

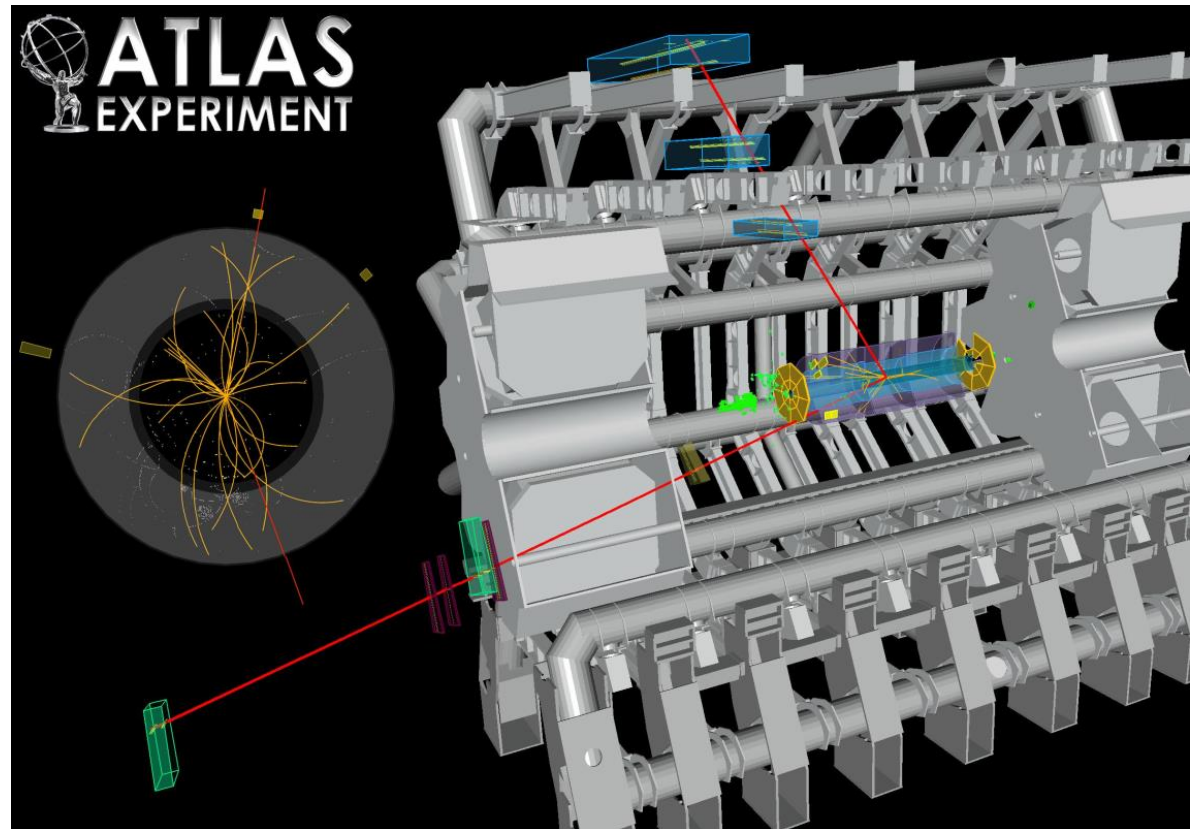

# Big Analysis of Muons in ATLAS (BAMA)

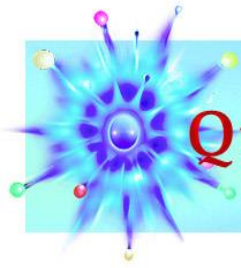



QuarkNet

# The LHC and New Physics

*It's a time of exciting new discoveries in particle physics!*

*At CERN, the LHC successfully completed Run I at 8 TeV of collision energy, confirming that the measurements correspond well to the **Standard Model** and then finding the Higgs boson. The LHC is now into Run II at an amazing 13 TeV and the task is to look for new phenomena...and we are off to a great start.*



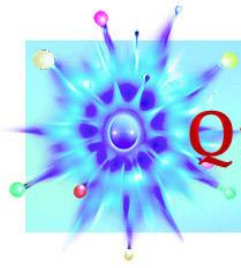

**QuarkNet**

# The LHC and New Physics

The LHC is buried ~100 m below the surface near the Swiss-French border.

beams accelerated in large rings  
(27 km circumference at CERN)

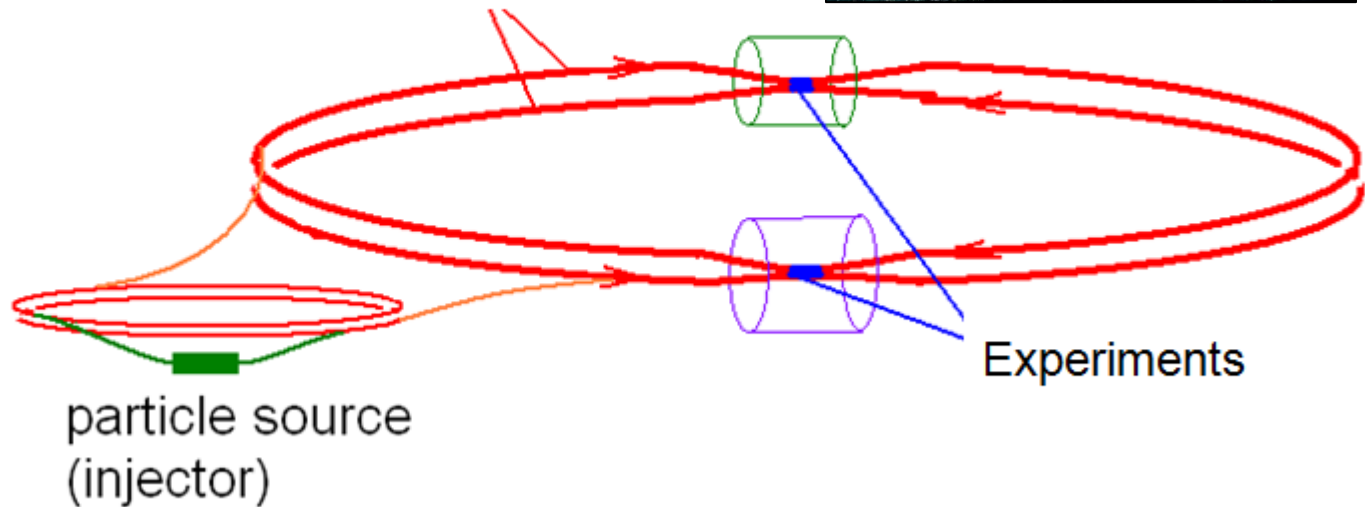

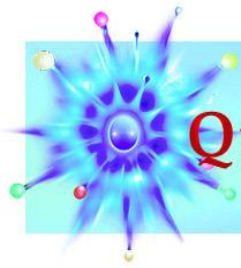

## Generic Design

Cylinders wrapped around the beam pipe

From inner to outer . . .

Tracking

Electromagnetic calorimeter

Hadronic calorimeter

Magnet\*

Muon chamber

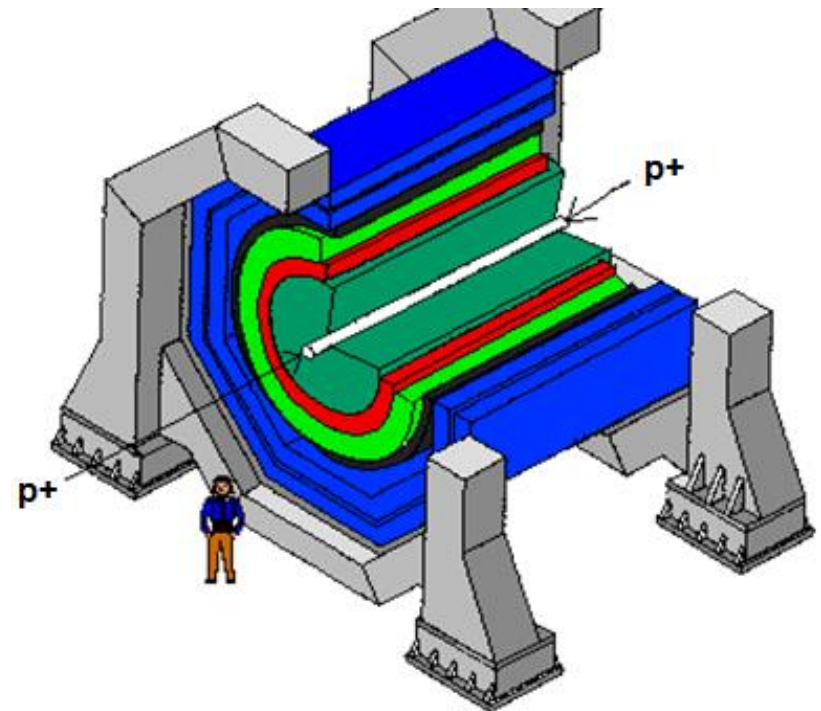

*\* Location of magnet depends on specific detector design.*

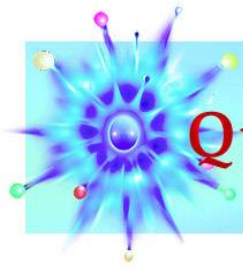

QuarkNet

## Proton Interactions

If each beam proton has energy 4 TeV....

- The total collision energy is  $2 \times 4 \text{ TeV} = 8 \text{ TeV}$ .
- But each particle inside a proton shares only a portion.
- So a newly created particle's mass **must be** smaller than the total energy.

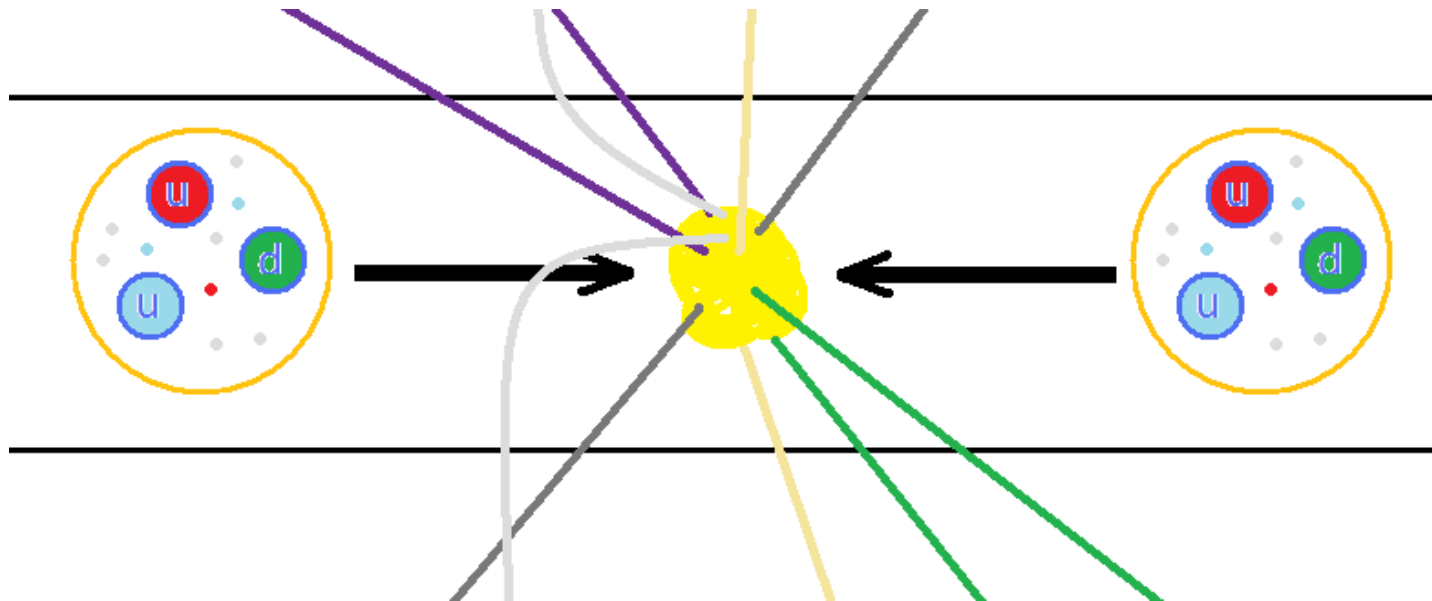

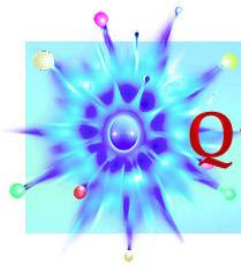

QuarkNet

# Particle Decays

Often, quarks are scattered in collisions.

As they separate, the binding energy between them converts to sprays of new particles called jets. Also, lower energy electrons and muons can emerge.

They are not what we are looking for.

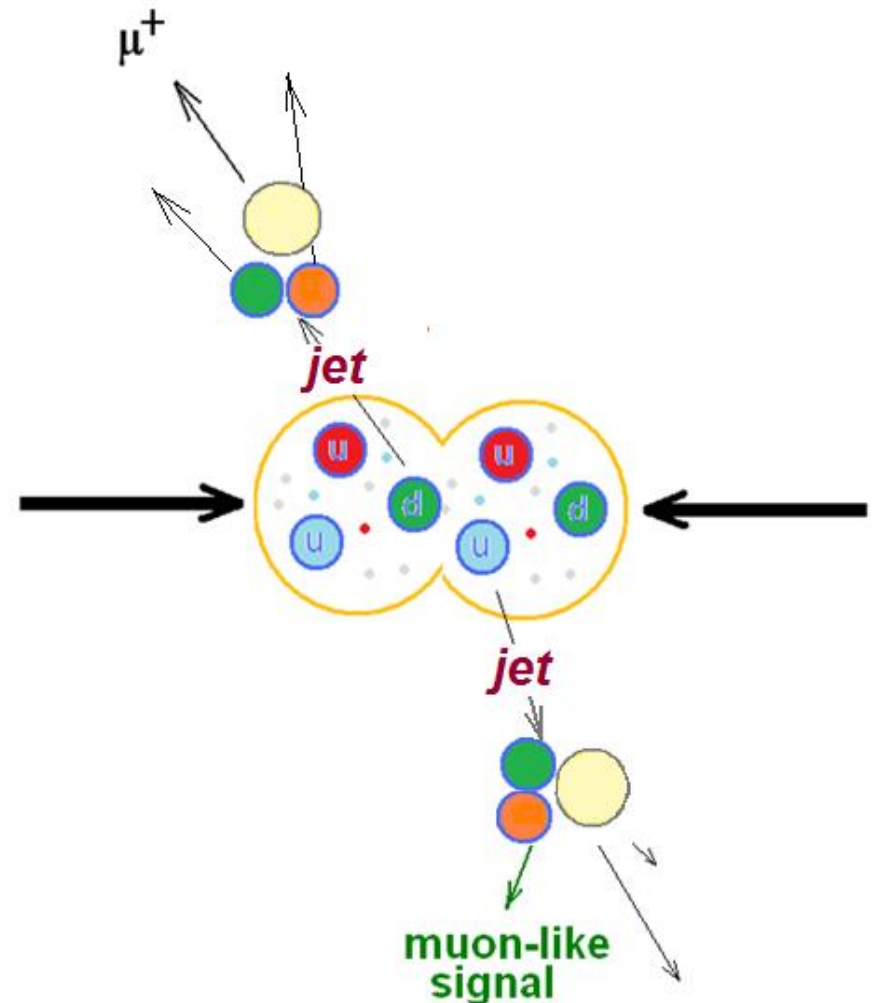

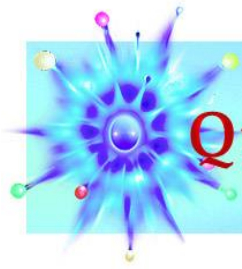

QuarkNet

# Particle Decays

We are looking for the Z boson, a particle with no charge that decays into two muons. \*

What do we know about the charges of the muons?  
What is the charge of the Z?

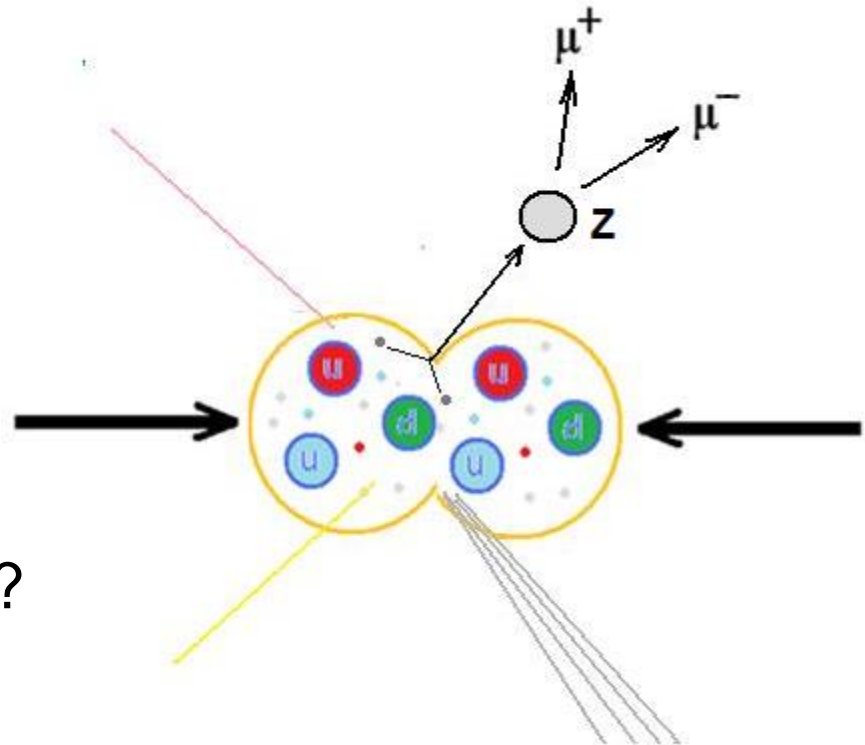

*\*The Z has other decays . . . but these are not what we are looking for.*

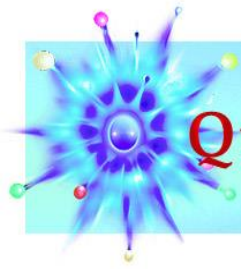

QuarkNet

## Particle Decays

A “dimuon” or “dielectron” event *might* be a decay of the particle that we are interested in.

It may be hard to find the tracks we want unless we make a “cut” on low- energy tracks.

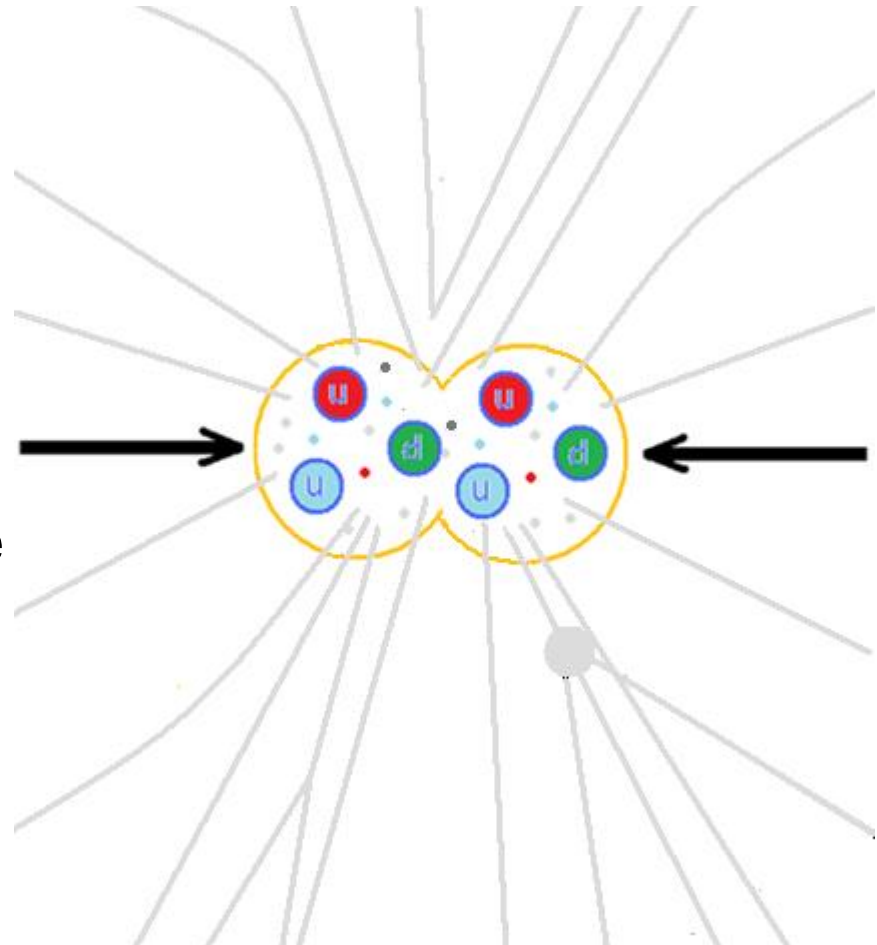



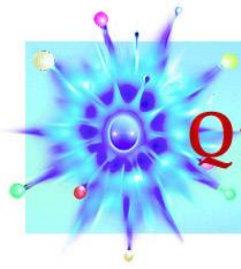

QuarkNet

## Particle Decays

If we cut out all tracks below, say, 10 GeV momentum, the picture is clearer.

Today, we will filter many events to find  $Z \rightarrow \mu \mu$  signals and use momentum information from these to find the mass of the Z boson.

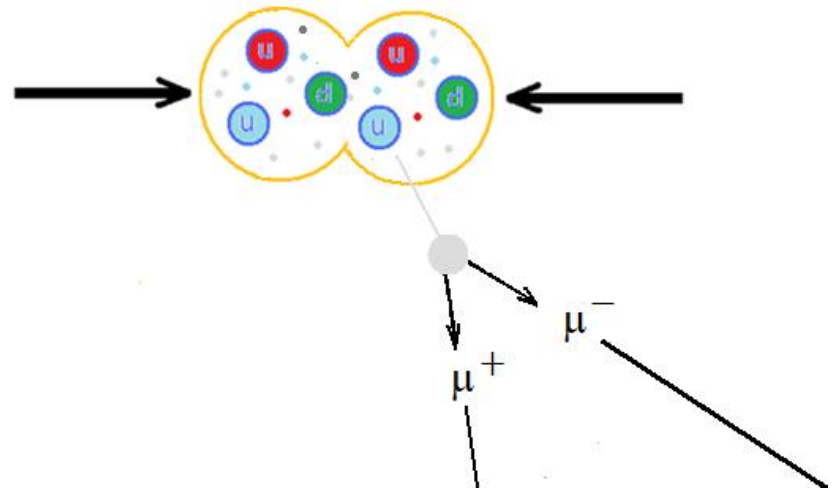

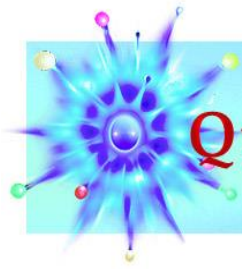

QuarkNet

# Particle Decays

The Higgs boson was discovered by CMS and ATLAS and announced on July 4, 2012.

This long-sought particle is part of the “Higgs mechanism” that accounts for other particle having mass.

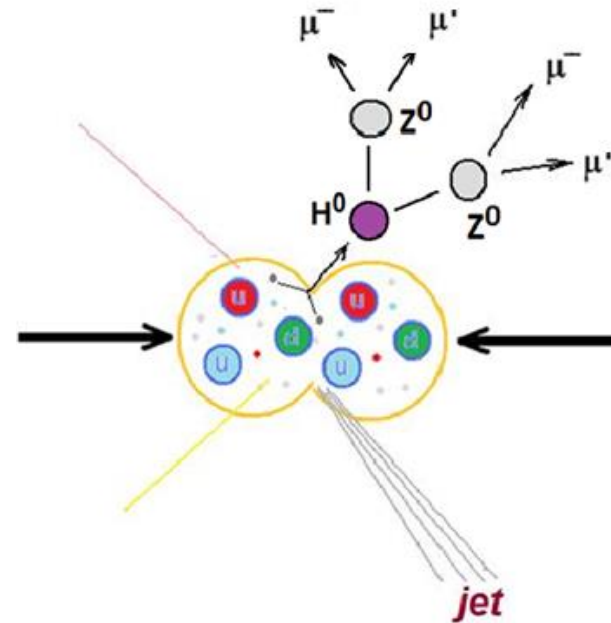

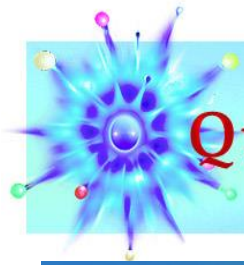

QuarkNet

Helping Develop America's Technological Workforce

# HYPATIA 4 Event Display

HY.P.A.T.I.A  
Hybrid Pupil's Analysis Tool for Interactions in ATLAS

Start
HYPATIA 1
HYPATIA 2
HYPATIA 3
HYPATIA 4
Exercises
Batch
Help

HELLENIC REPUBLIC  
**National and Kapodistrian University of Athens**  
EST. 1837

p
p<sub>T</sub>
φ
η
m<sub>ee</sub>
m<sub>μμ</sub>
m<sub>ll</sub>
<
>

m<sub>μμ</sub> [GeV] Events:3 Mean:750.3

RMS:476.7

Event: 4/4000 (1602/110158026) 2012-01-01  
 ETMiss: 173.82 GeV φ: -0.93 rad

← Previous Event
→ Next Event
+ Insert Electron
+ Insert Muon
- Delete Track
p<sub>T</sub> 10 GeV
4000\_eve...
00event0...
Start

Track	+/-	p [GeV]	p <sub>T</sub> [GeV]	φ [rad]	θ [rad]	Event Name	ETMiss [GeV]	Track	p [GeV]	+/-	p <sub>T</sub> [GeV]	φ [rad]	η	m <sub>ll</sub> [GeV]	m <sub>μμ</sub> [GeV]	e/μ
Tracks_0	-	605.289	581.953	2.195	1.849	00event00...	23.199	Tra...	216.96	-	42.63	-1.48	2.31	94.16		μ
Tracks_2	+	383.523	380.634	-0.908	-1.694	00event00...	97.101	Tra...	93.33	+	42.9	1.78	1.41			μ
						00event00...		Tra...	556.34	-	515.76	2.04	0.39	1212.60		μ
						00event00...		Tra...	699.81	+	697.24	-1.19	0.09			μ
						00event00...	173.818	Tra...	605.29	-	581.95	2.19	-0.28	944.10		μ

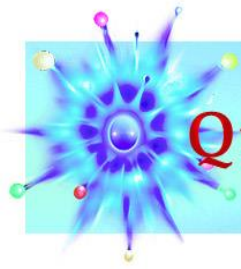

QuarkNet

# HYPATIA Event Display

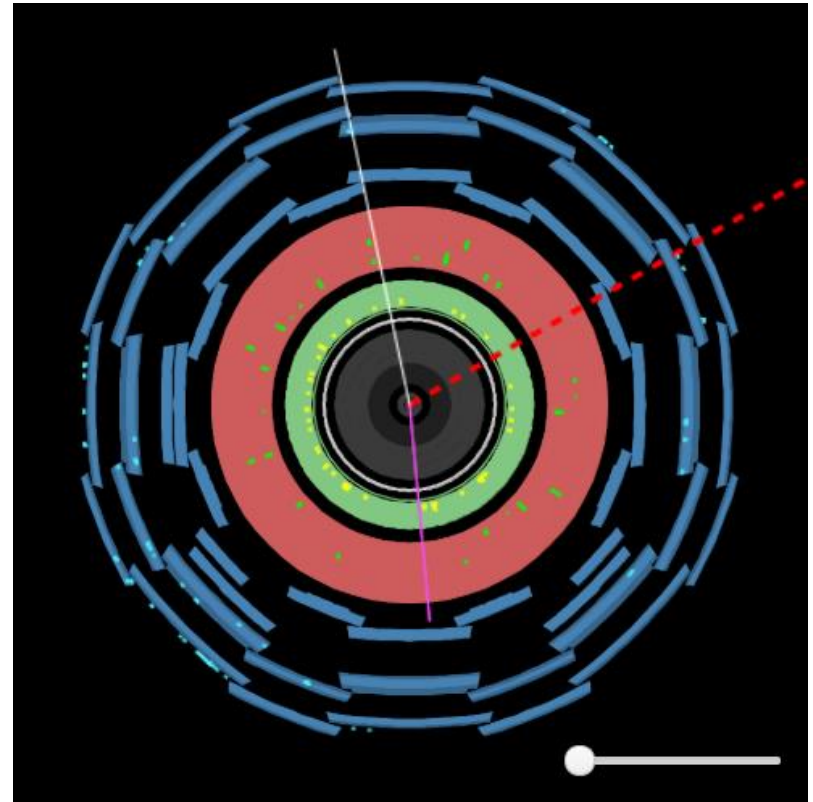
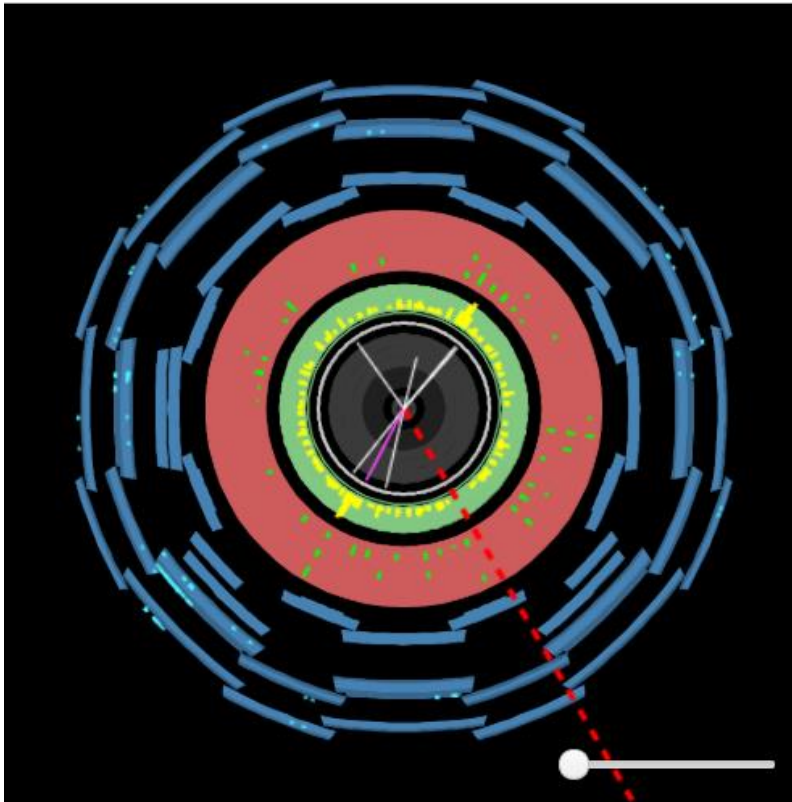

Which of these events has 2 muons? 4 muons?

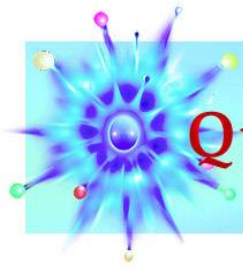

QuarkNet

# HYPATIA Event Display

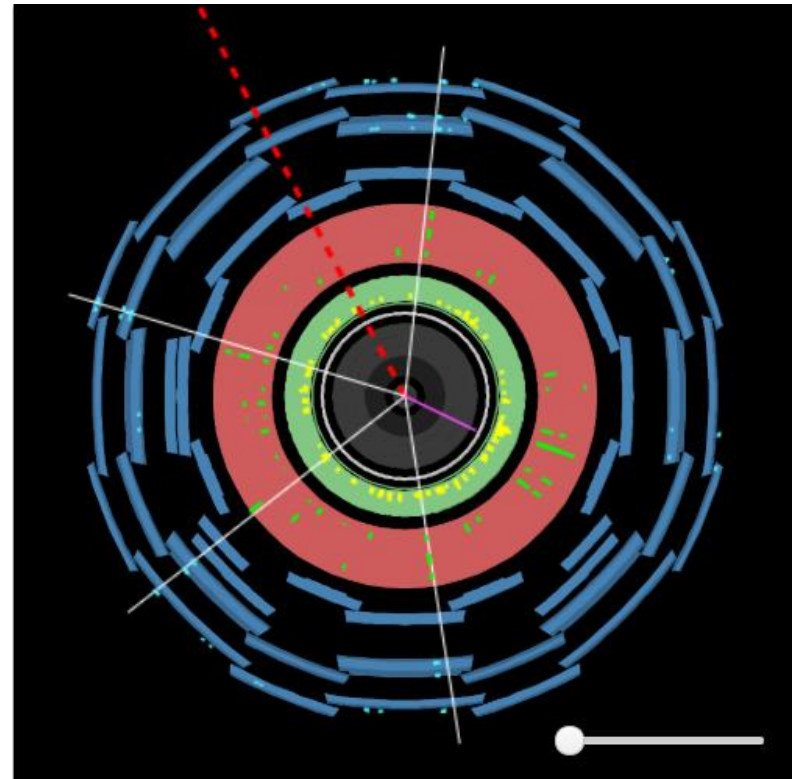
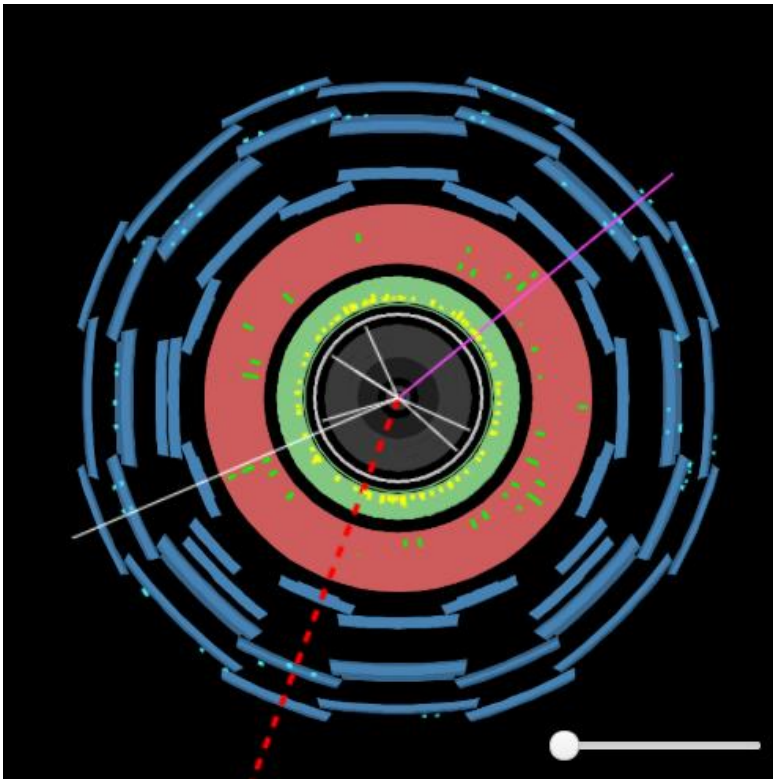

Which of these events has 2 muons? 4 muons?

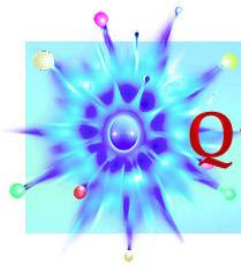

QuarkNet

## Some rules for BAMA

1. Pick out the long (muon) tracks that go beyond the electromagnetic calorimeter, which is **green** in HYPATIA.
2. Look for events with 2 or 4 muons.
3. The net charge of the muons must be zero, so a pair would be a  $\mu^+$  and a  $\mu^-$ .
4. If an event does not have 2 or 4 muons, skip it.
5. Don't get hung up on any one event.
6. Don't worry if you do not get all 50 events.