

# CMS-W2D2

Measurement for  
Masterclass-in-a-box  
Data Set 3

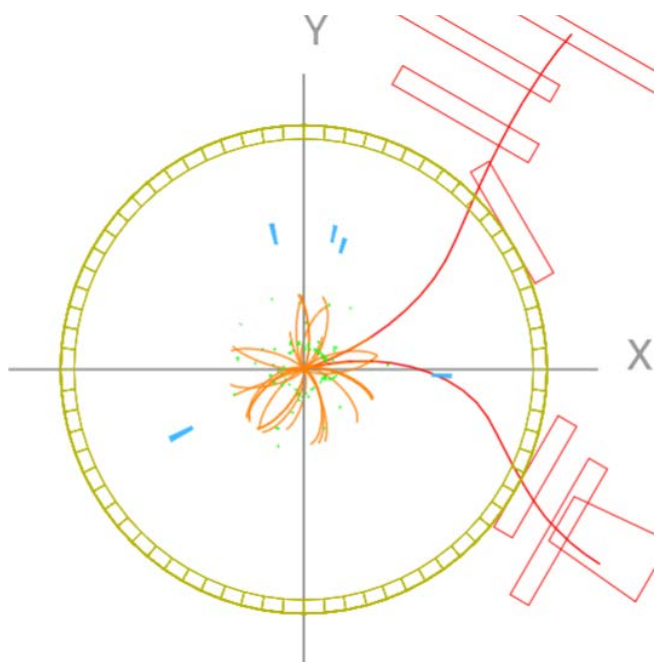

x-y view: measure  $\phi$

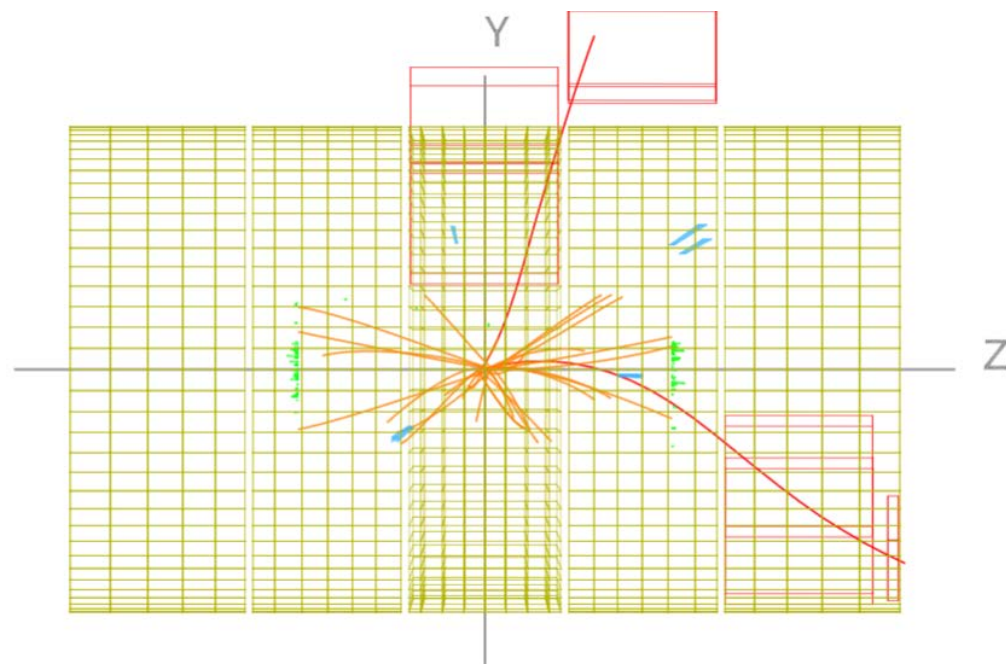

z-y view: measure  $\theta$

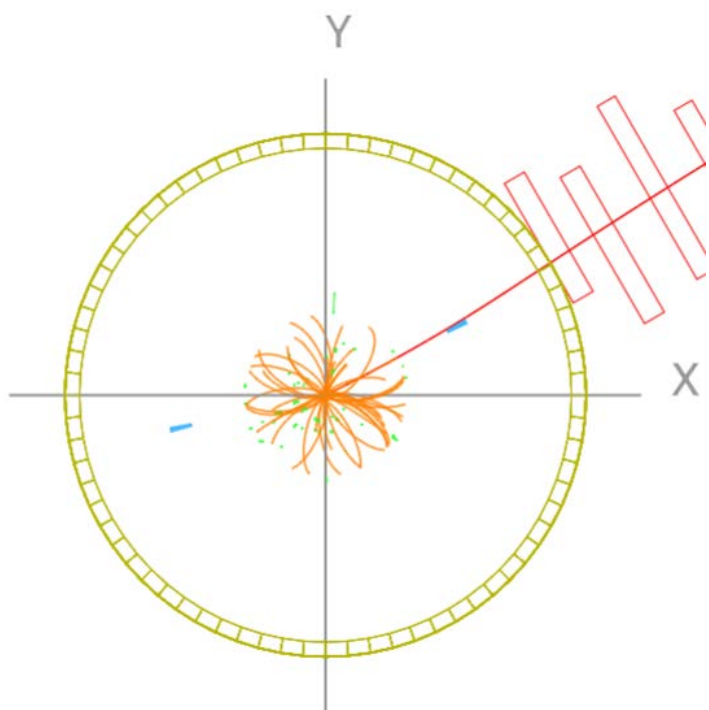

x-y view: measure  $\phi$

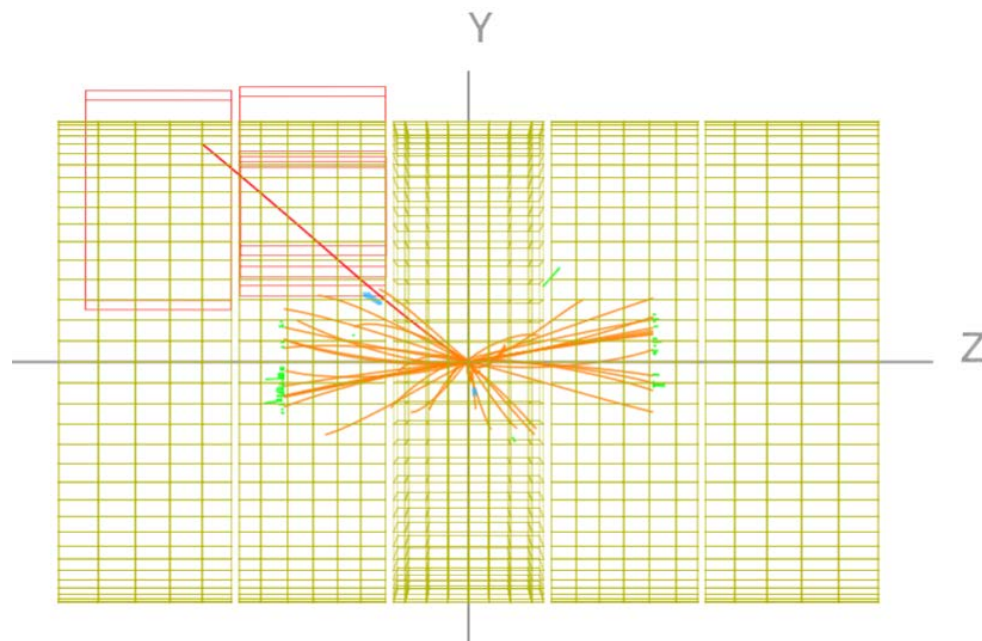

z-y view: measure  $\theta$

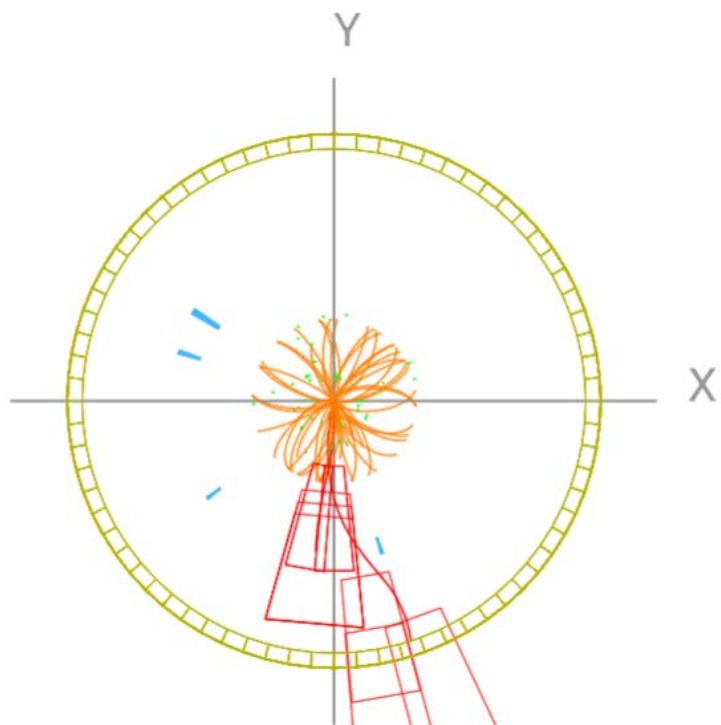

x-y view: measure  $\phi$

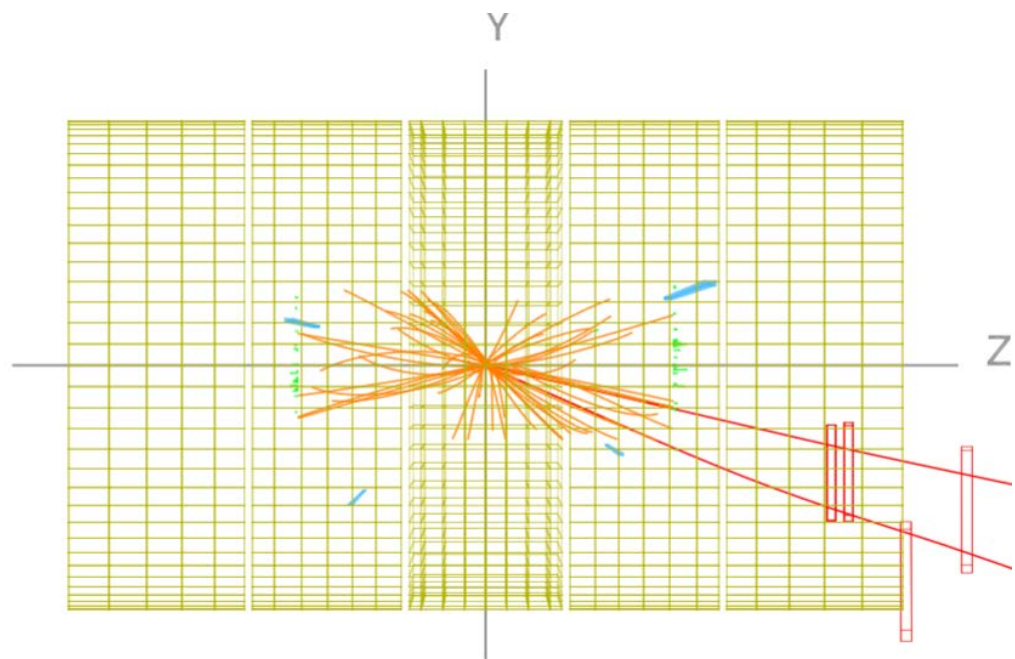

z-y view: measure  $\theta$

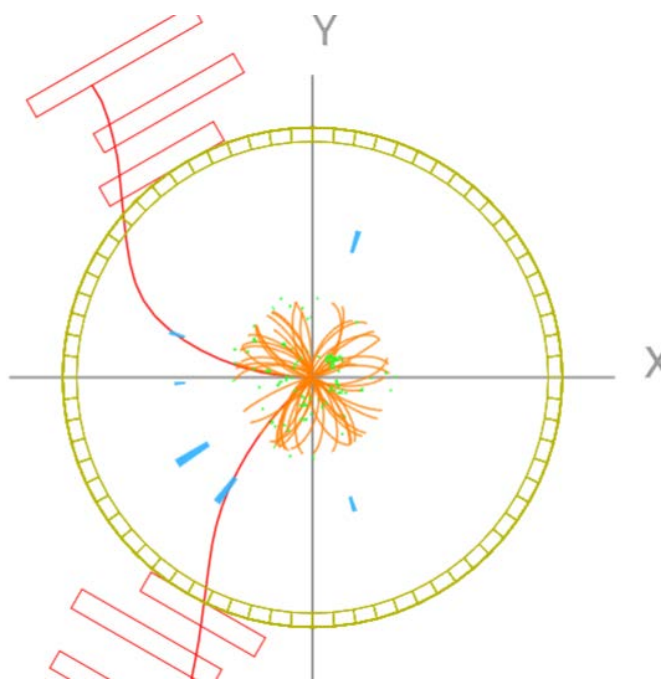

x-y view: measure  $\phi$

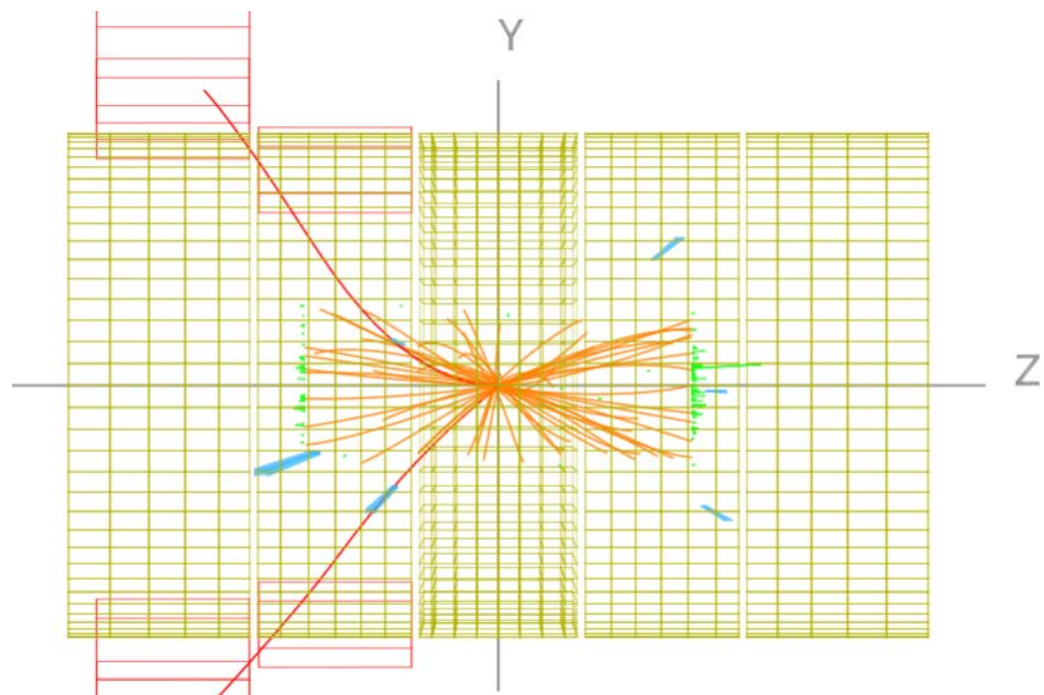

z-y view: measure  $\theta$

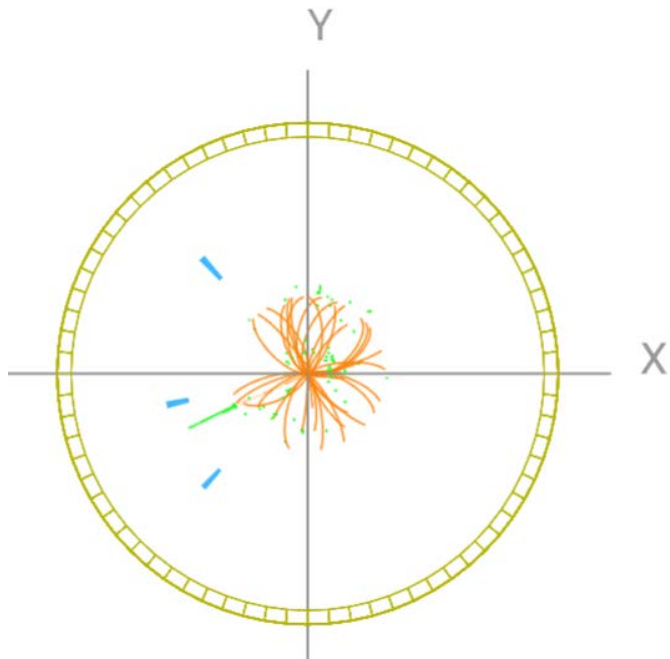

x-y view: measure  $\phi$

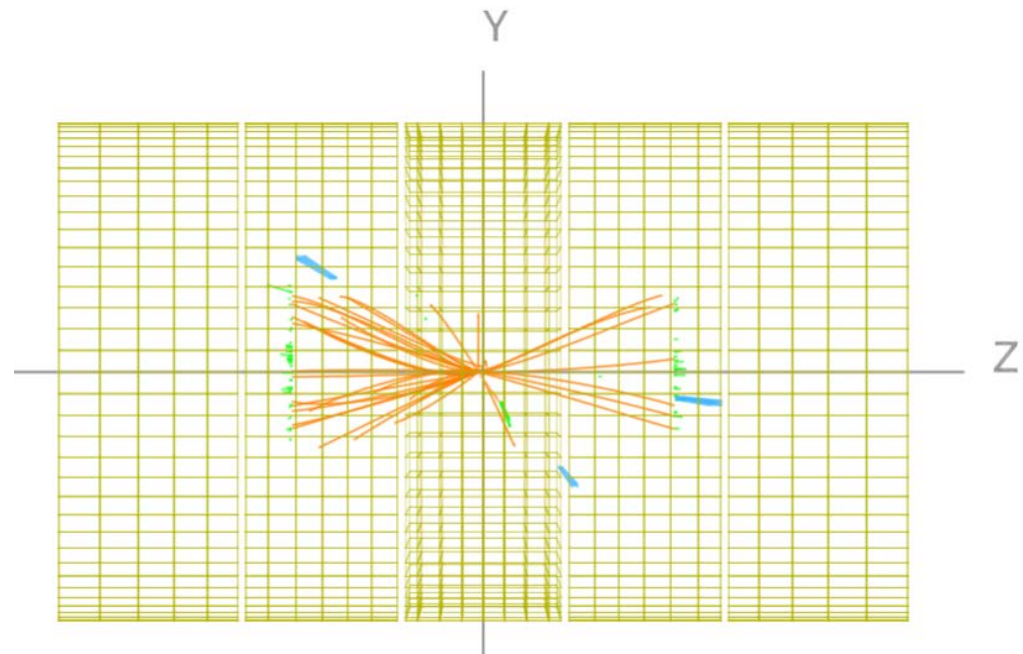

z-y view: measure  $\theta$



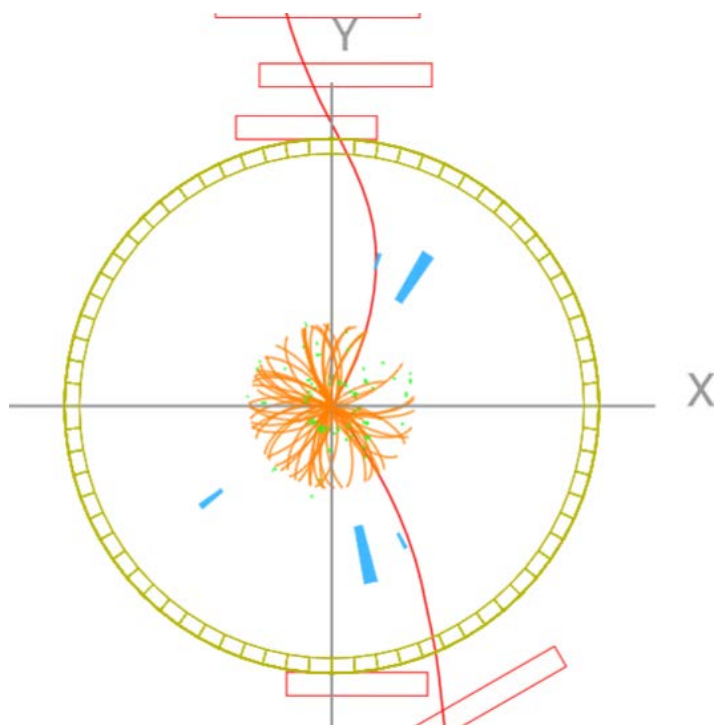

x-y view: measure  $\phi$

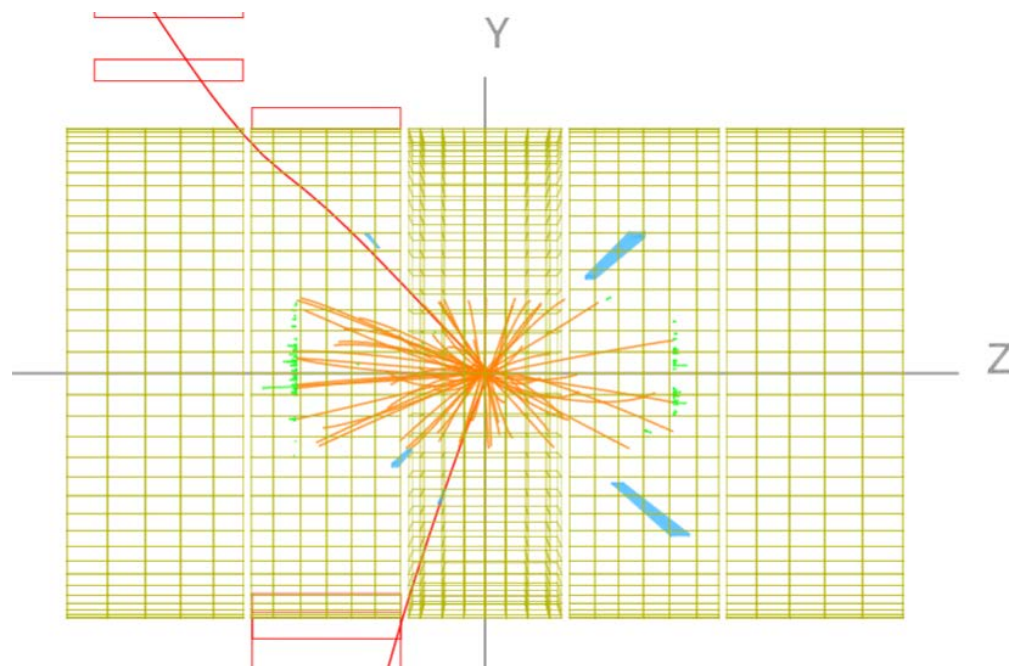

z-y view: measure  $\theta$

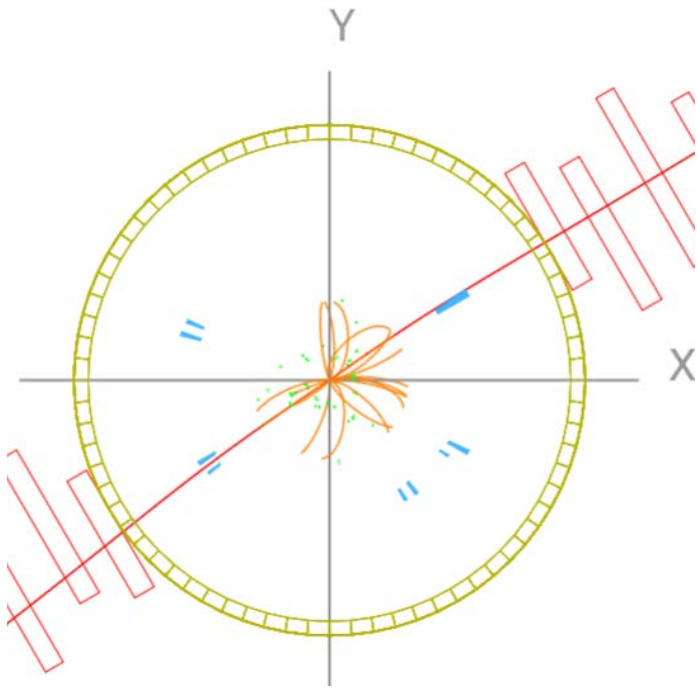

x-y view: measure  $\phi$

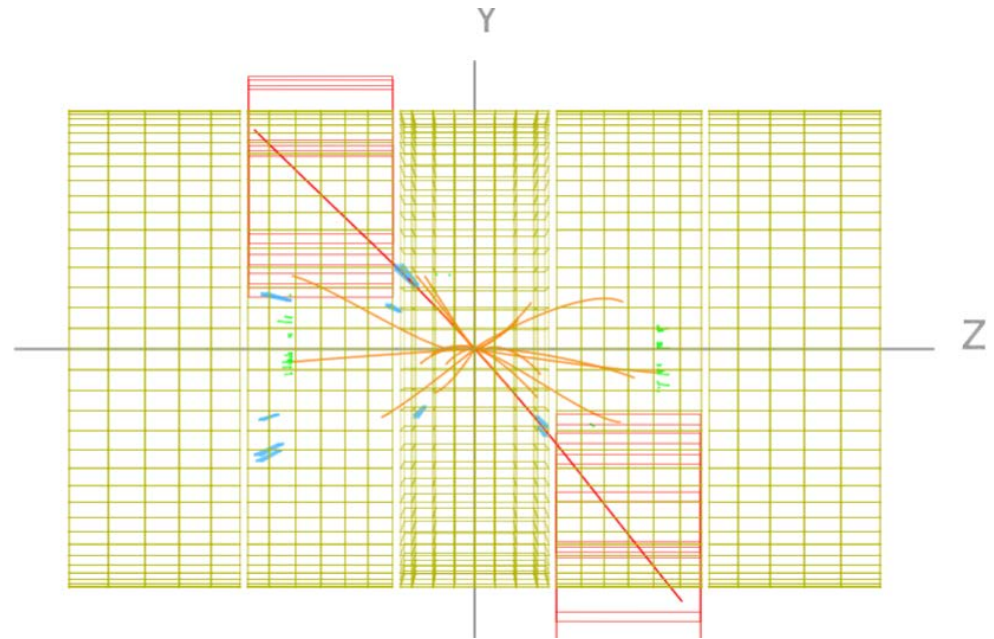

z-y view: measure  $\theta$

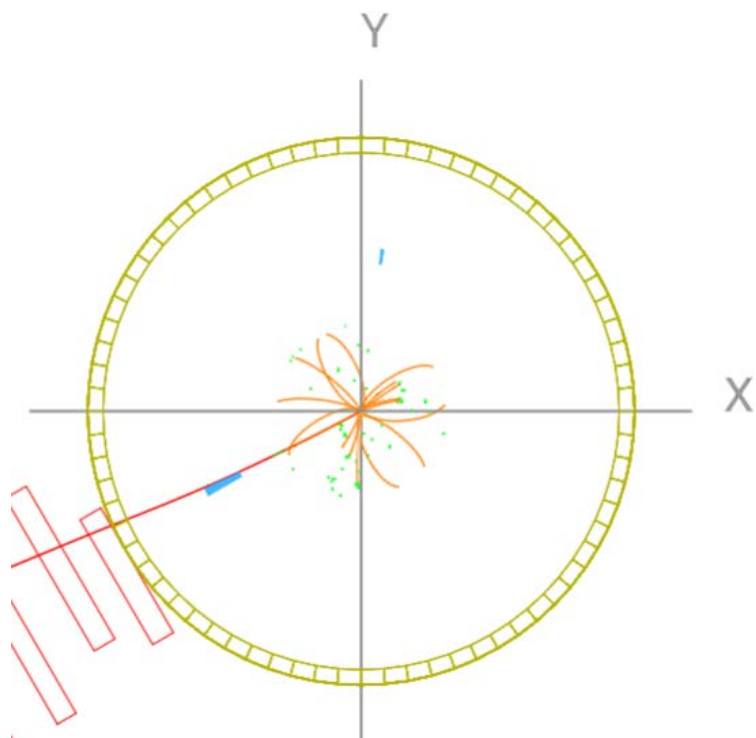
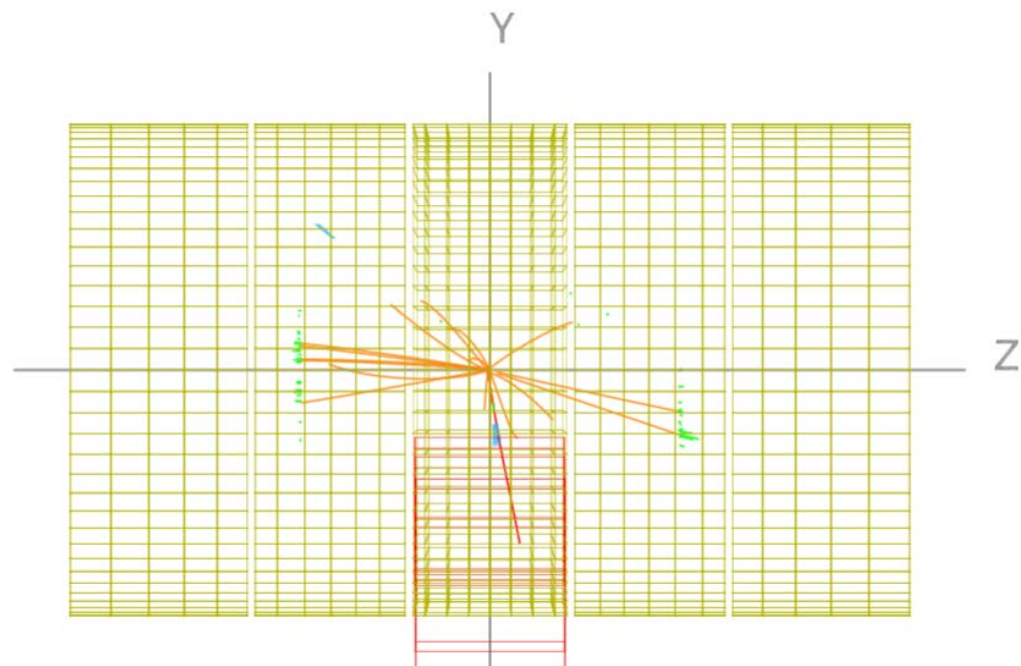

x-y view: measure  $\phi$ z-y view: measure  $\theta$

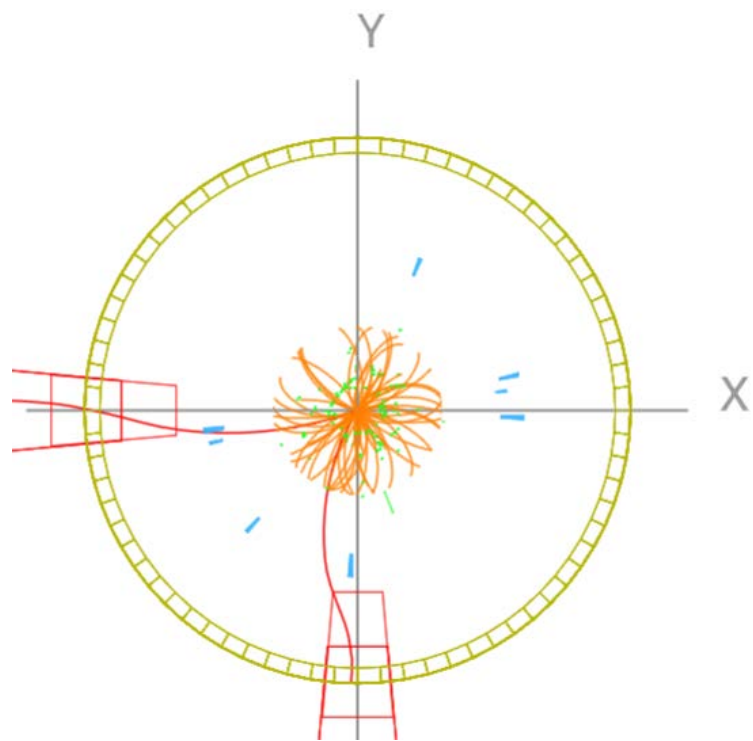

x-y view: measure  $\phi$

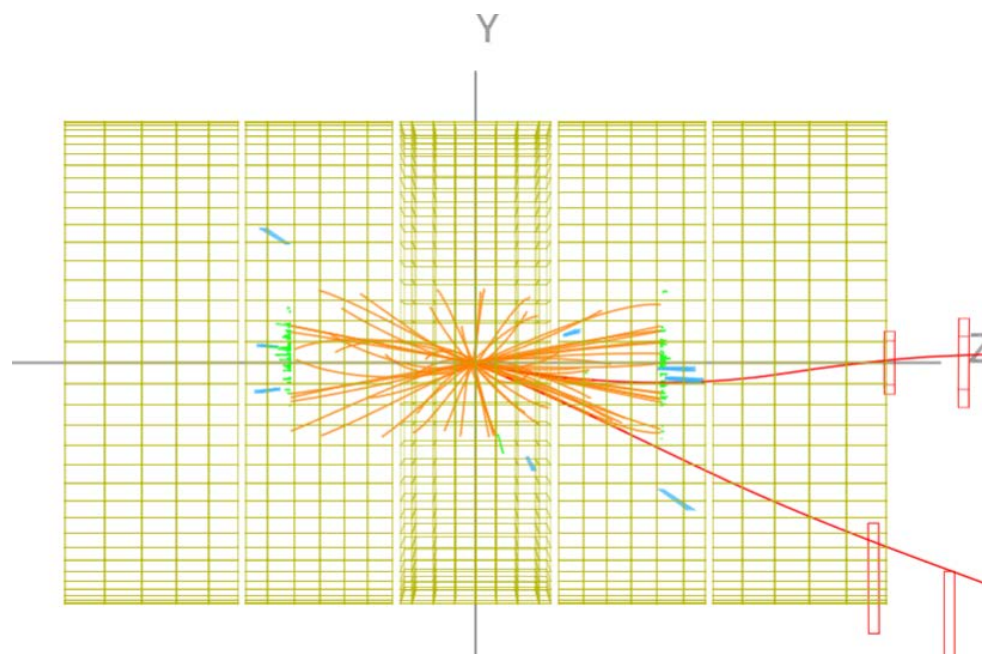

z-y view: measure  $\theta$

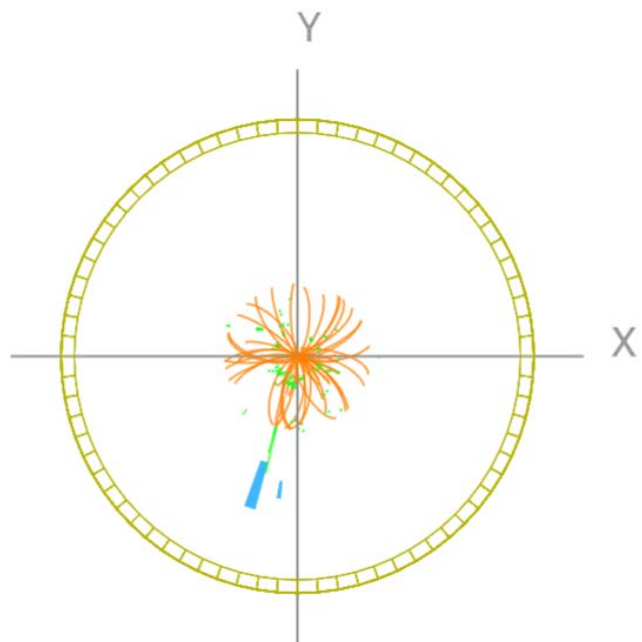

x-y view: measure  $\phi$

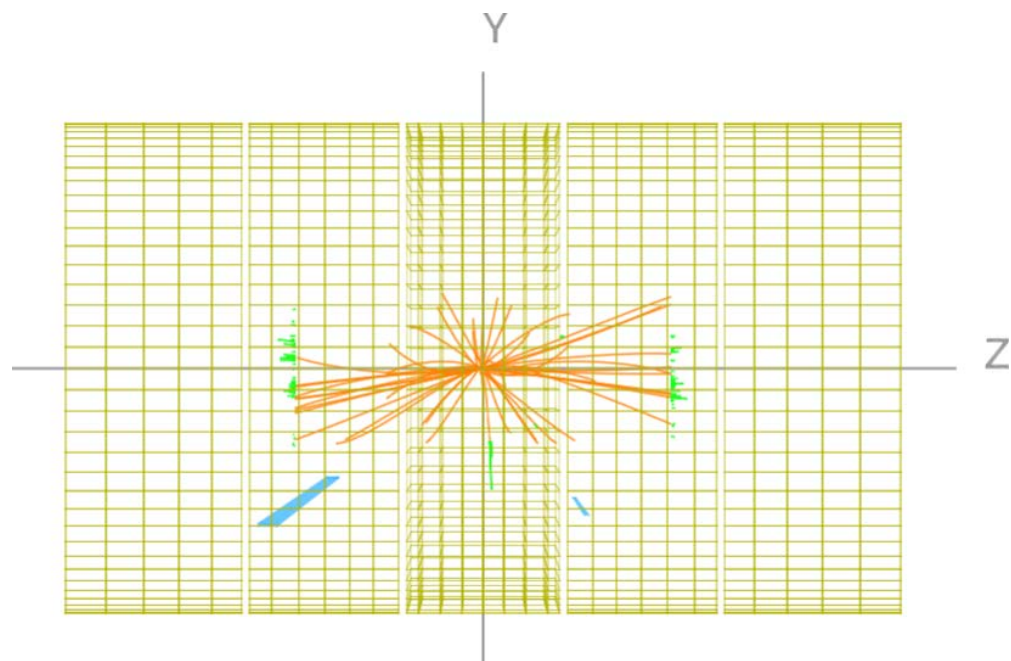

z-y view: measure  $\theta$

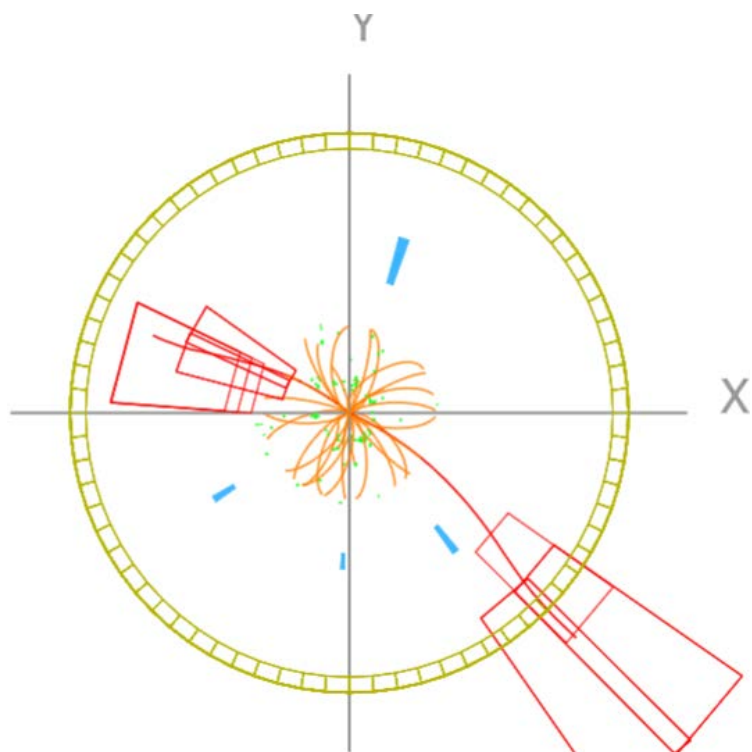

x-y view: measure  $\phi$

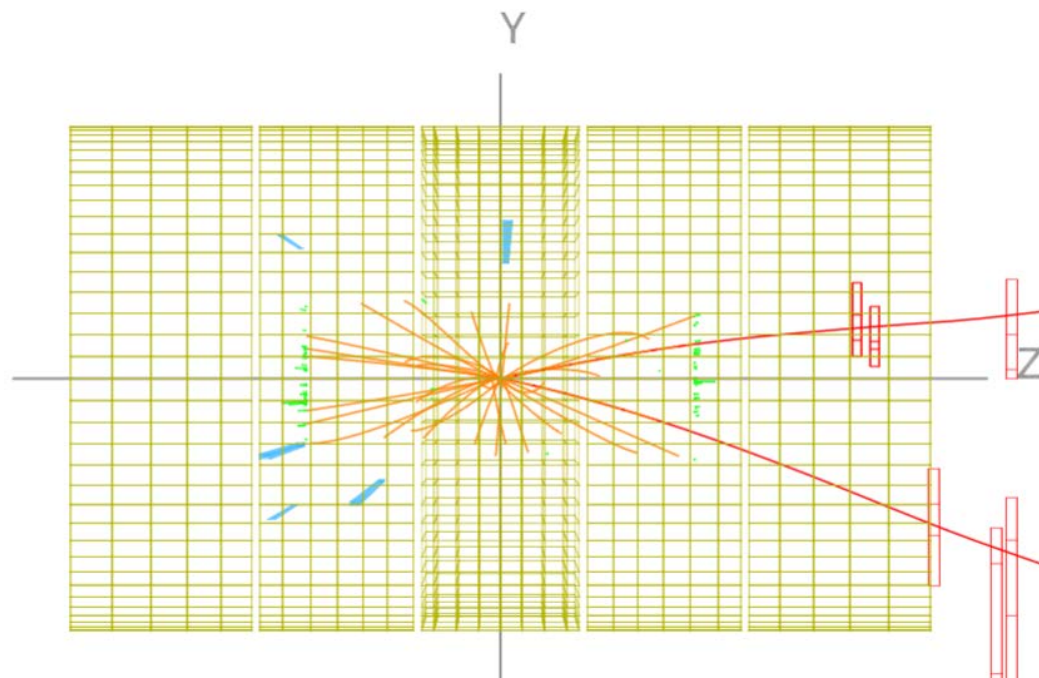

z-y view: measure  $\theta$

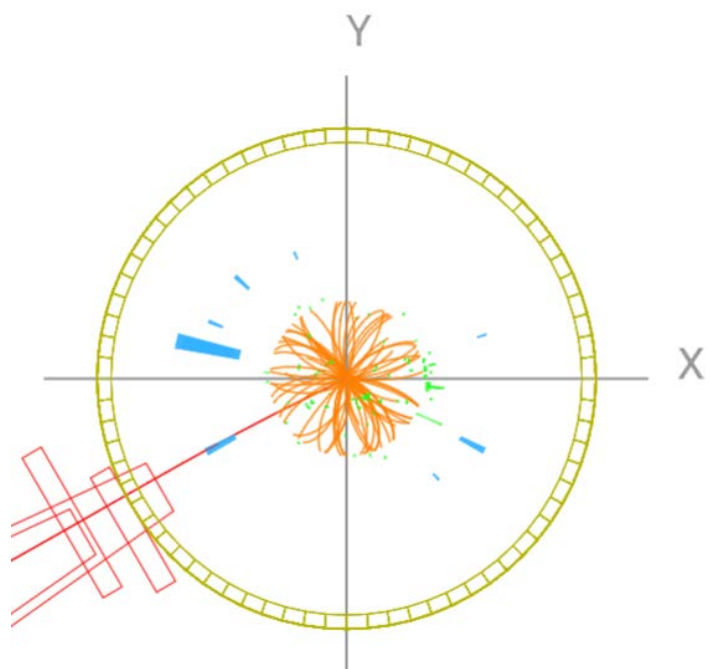

x-y view: measure  $\phi$

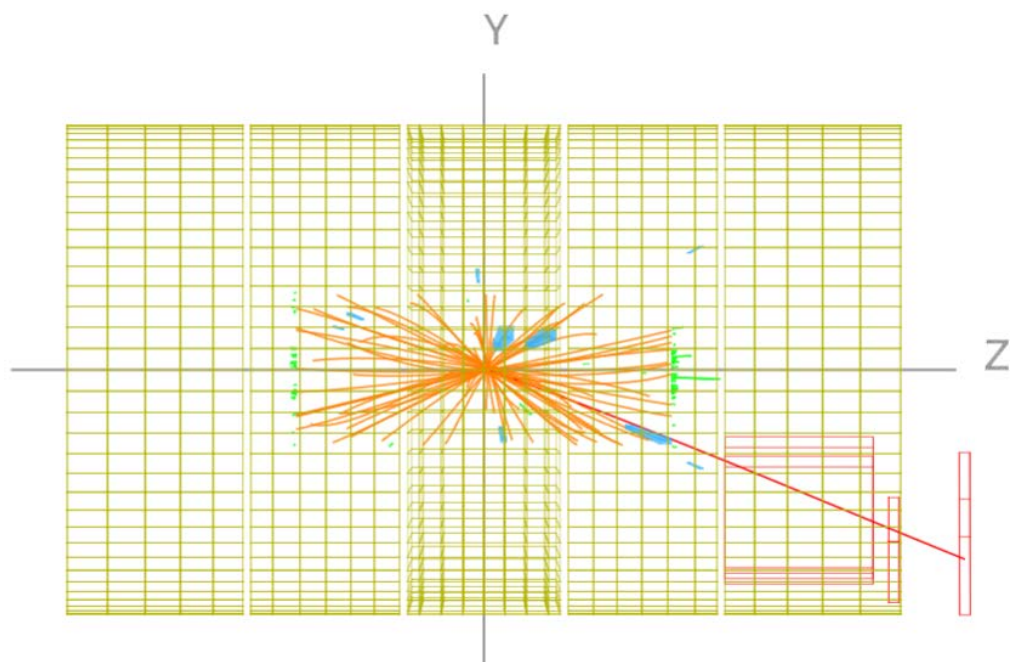

z-y view: measure  $\theta$



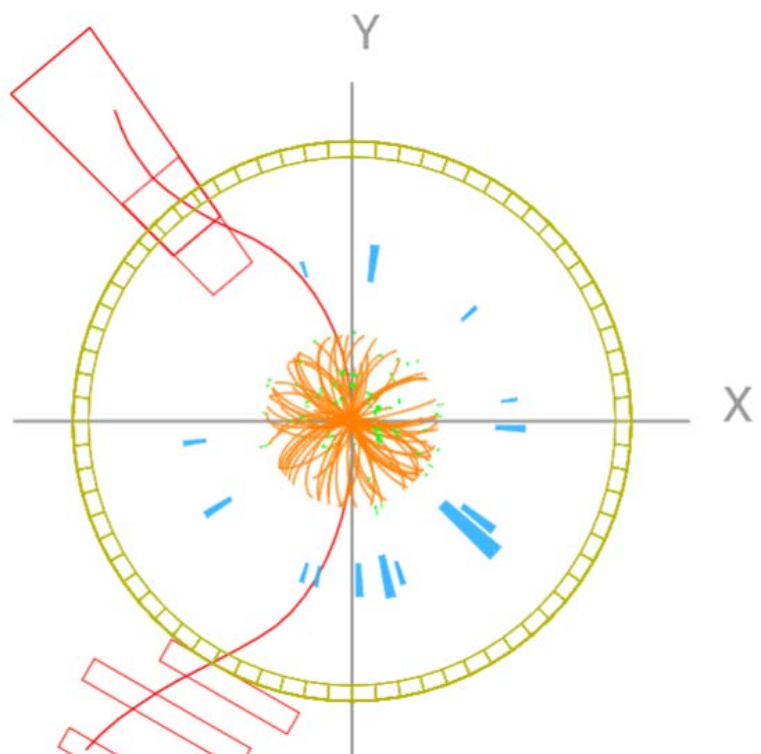

x-y view: measure  $\phi$

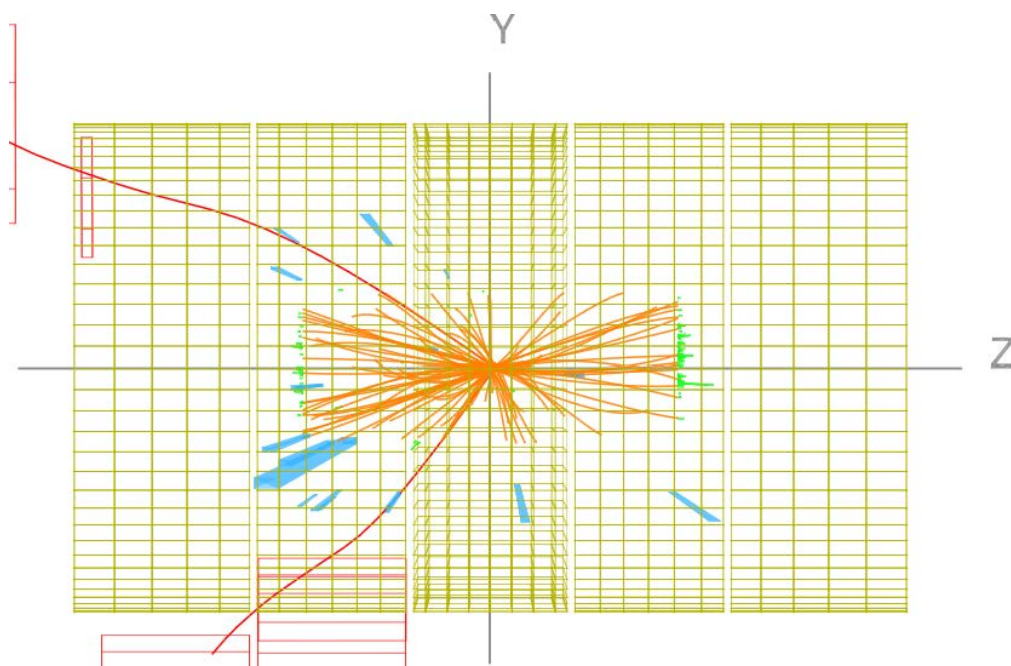

z-y view: measure  $\theta$



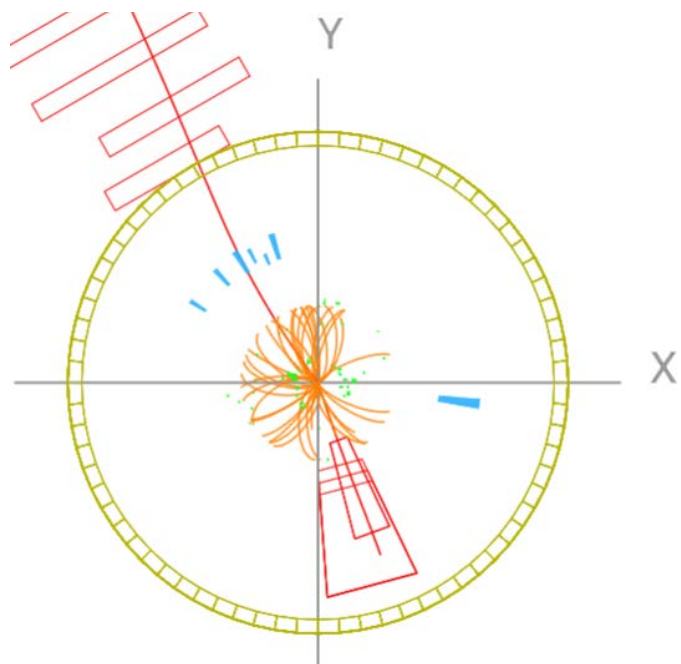

x-y view: measure  $\phi$

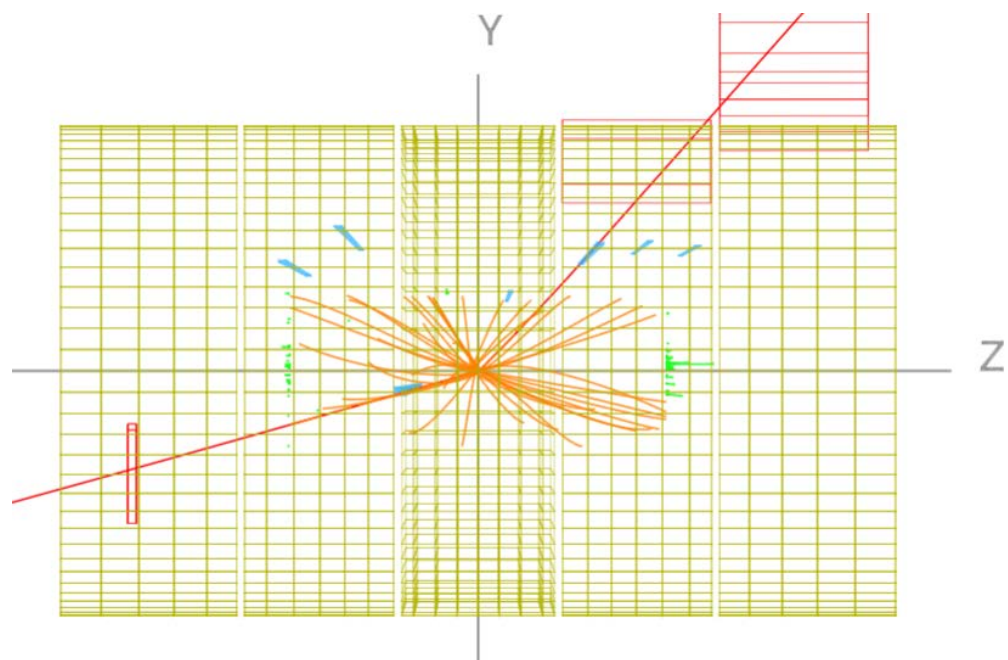

z-y view: measure  $\theta$

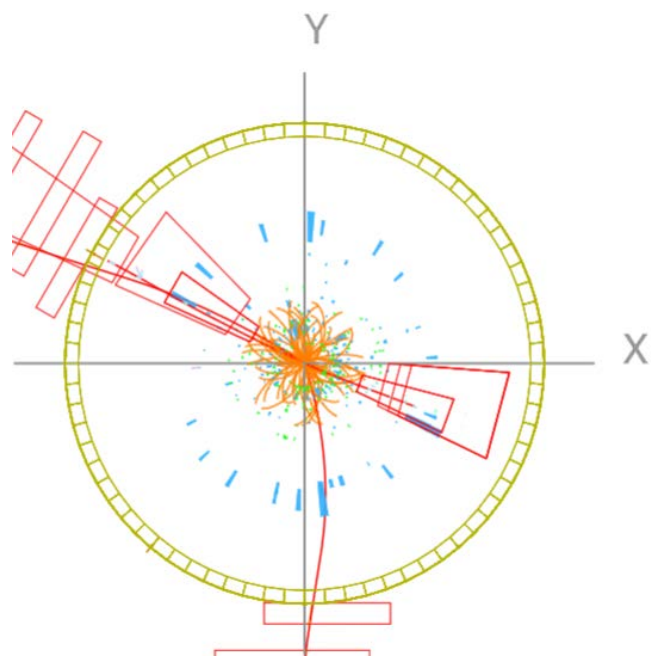

x-y view: measure  $\phi$

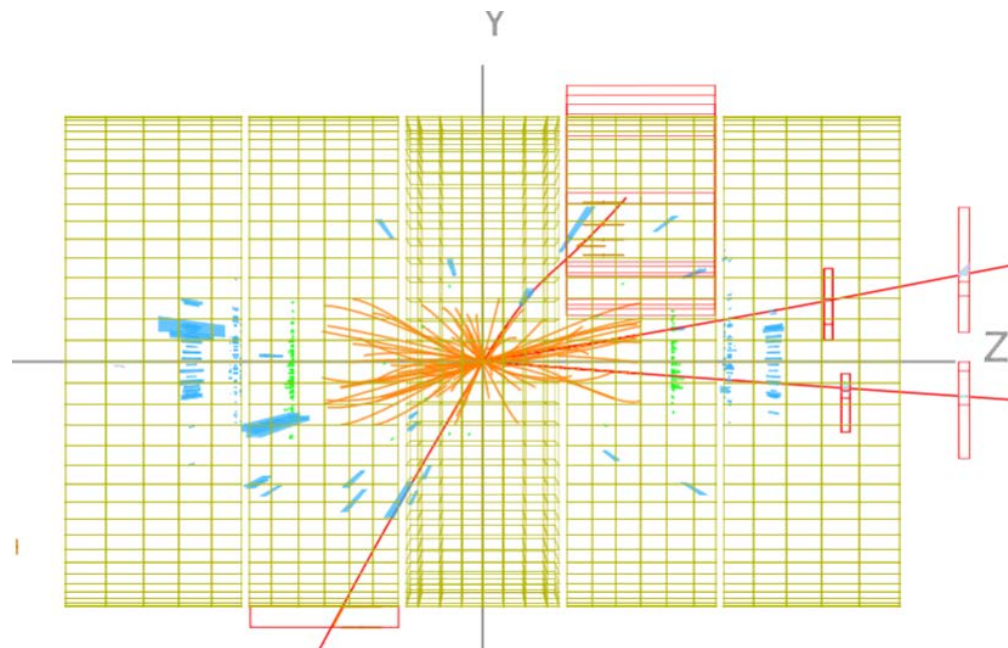

z-y view: measure  $\theta$

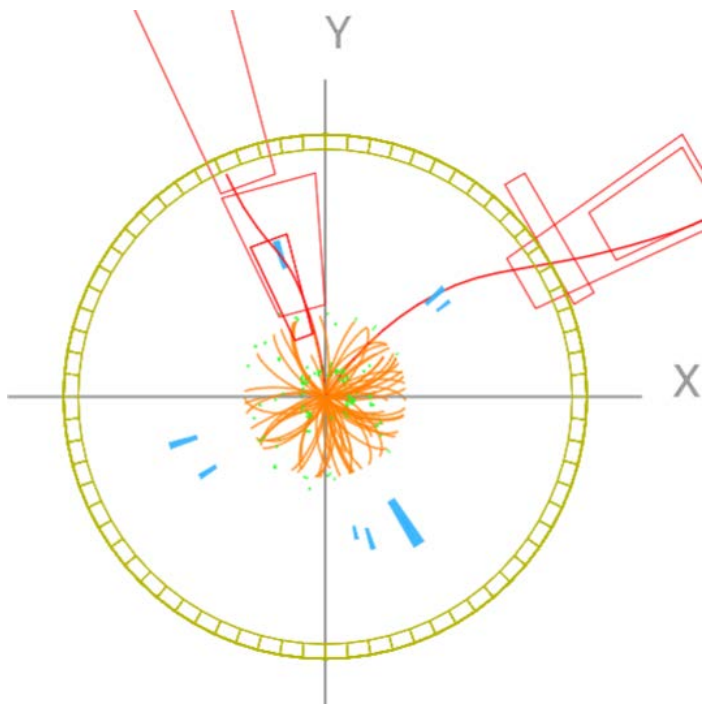

x-y view: measure  $\phi$

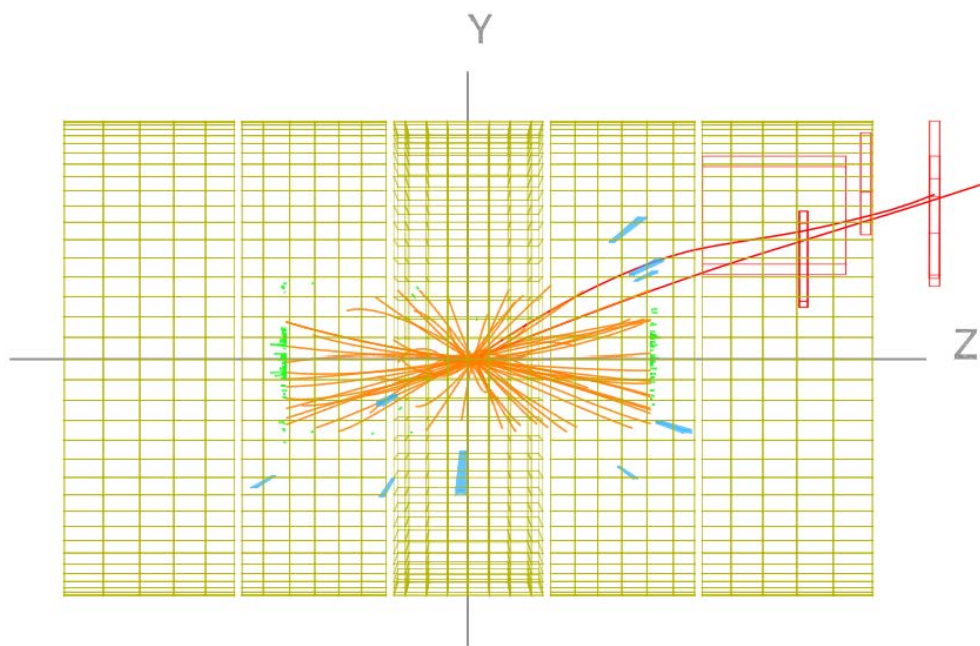

z-y view: measure  $\theta$

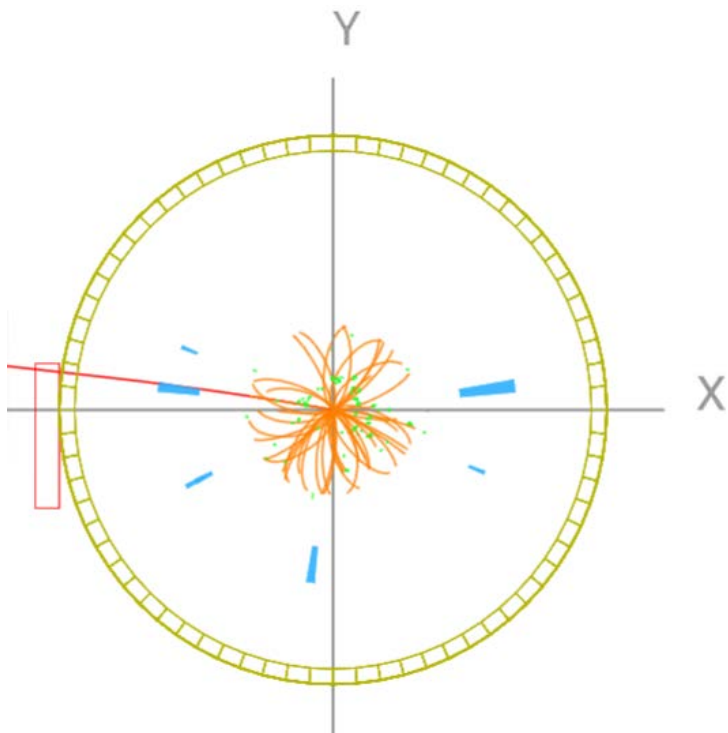

x-y view: measure  $\phi$

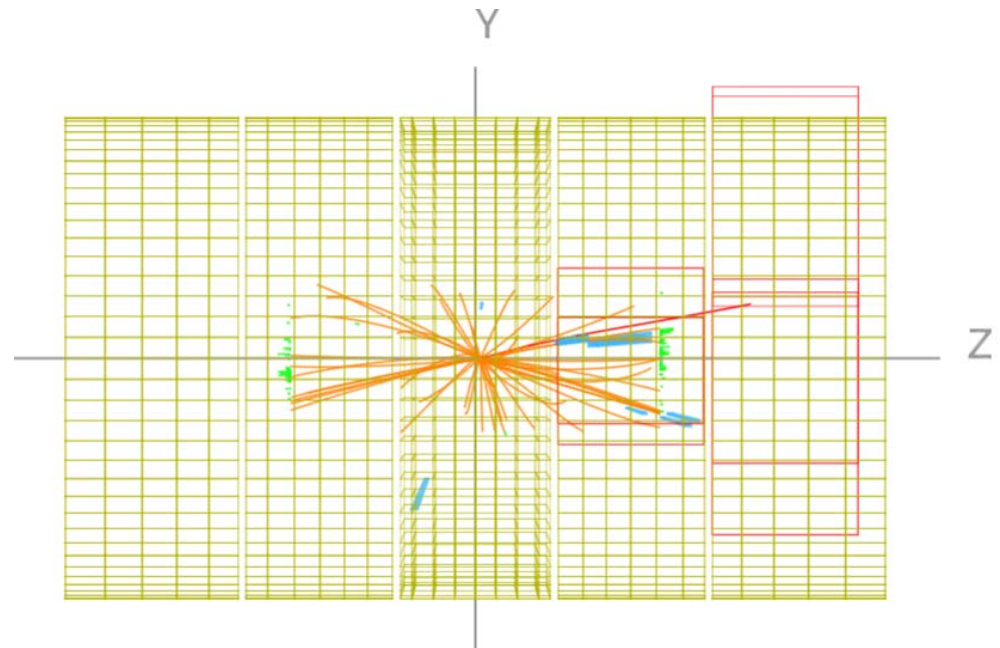

z-y view: measure  $\theta$

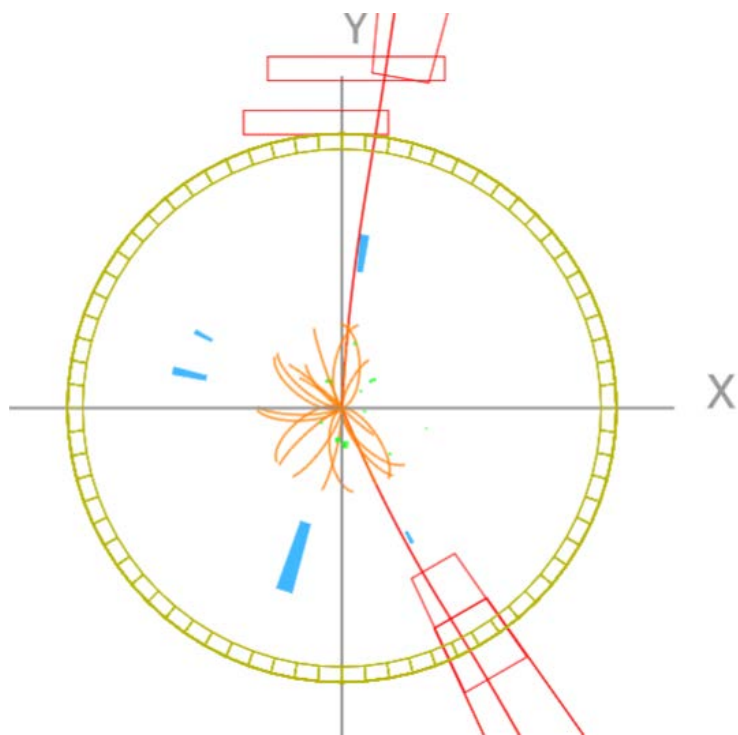

x-y view: measure  $\phi$

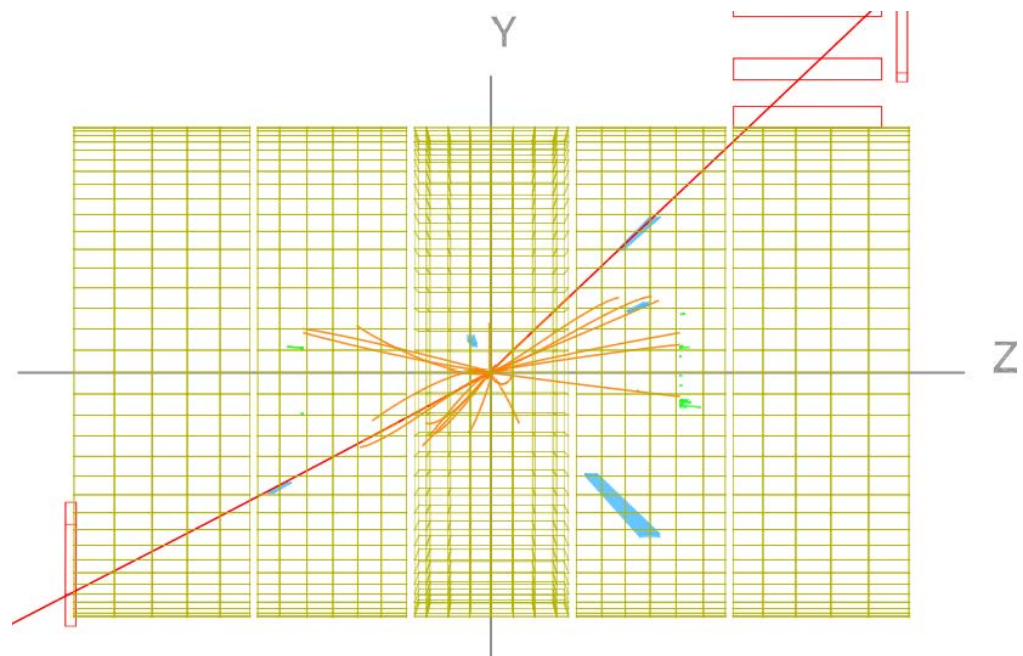

z-y view: measure  $\theta$



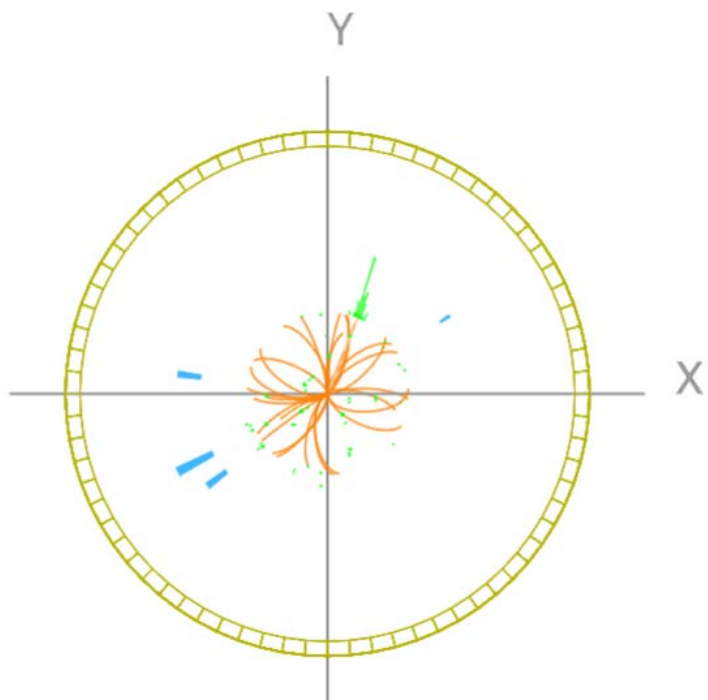

x-y view: measure  $\phi$

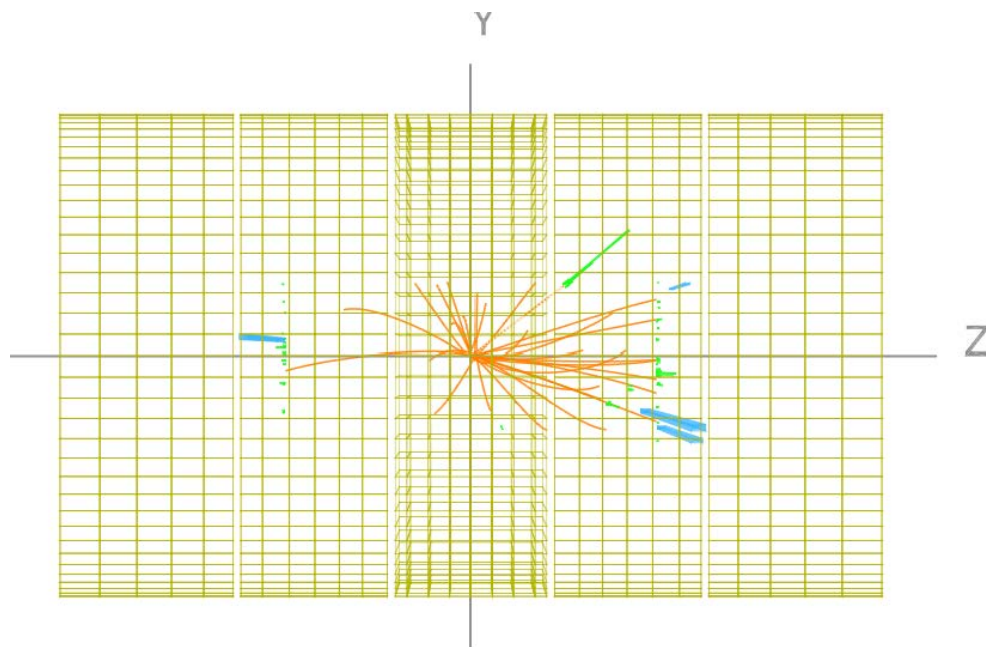

z-y view: measure  $\theta$



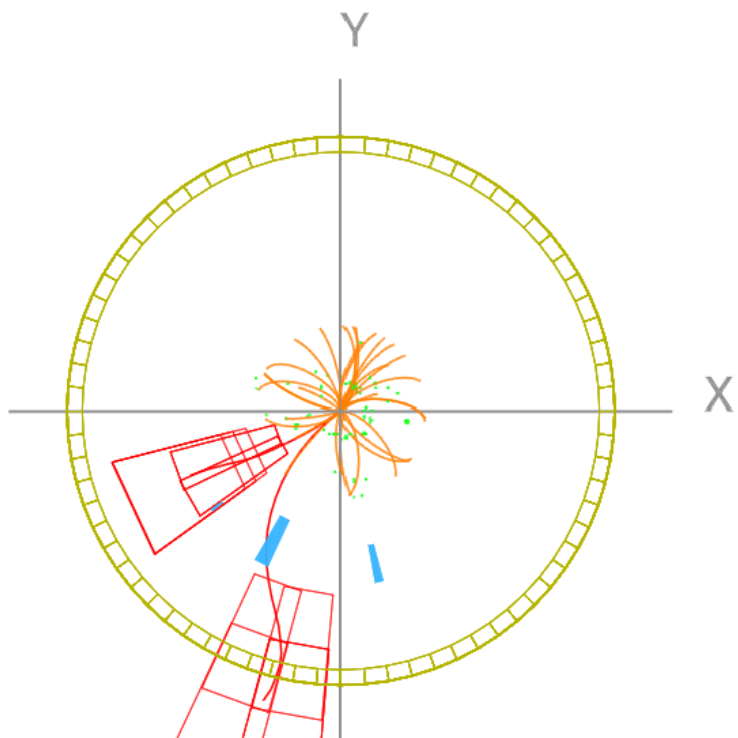

x-y view: measure  $\phi$

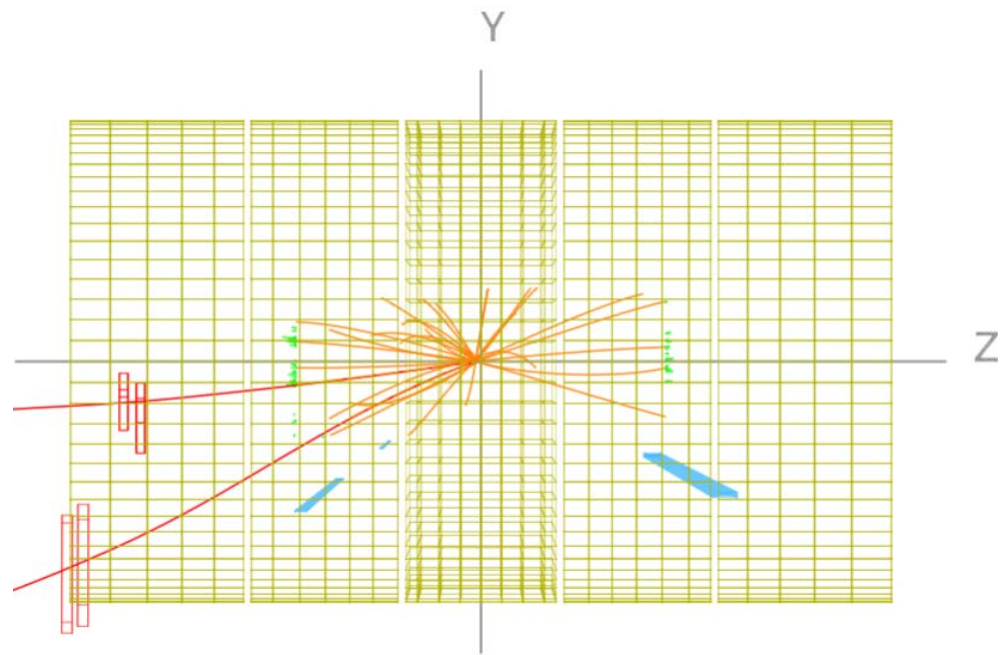

z-y view: measure  $\theta$

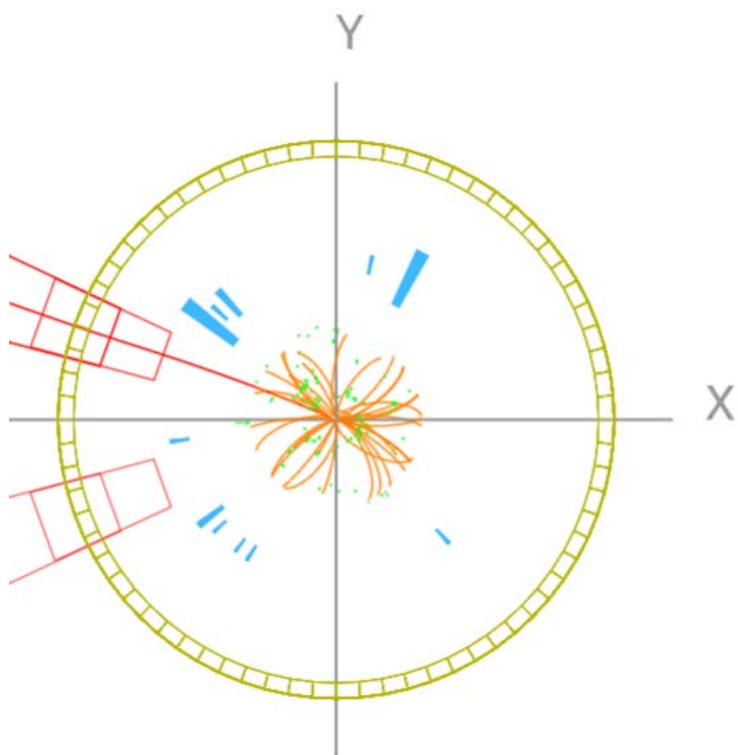

x-y view: measure  $\phi$

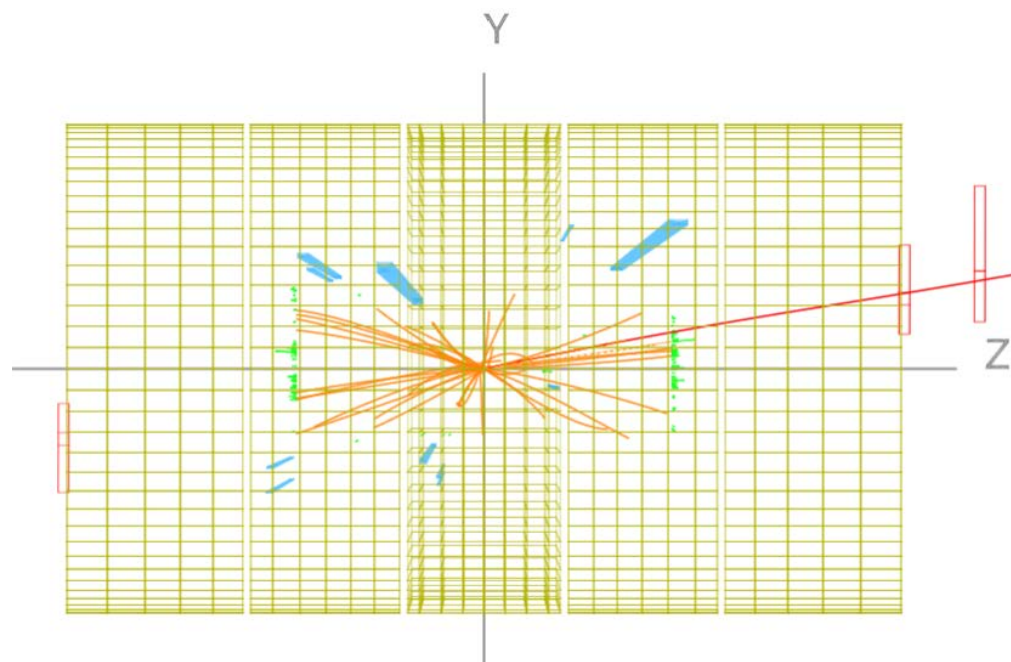

z-y view: measure  $\theta$

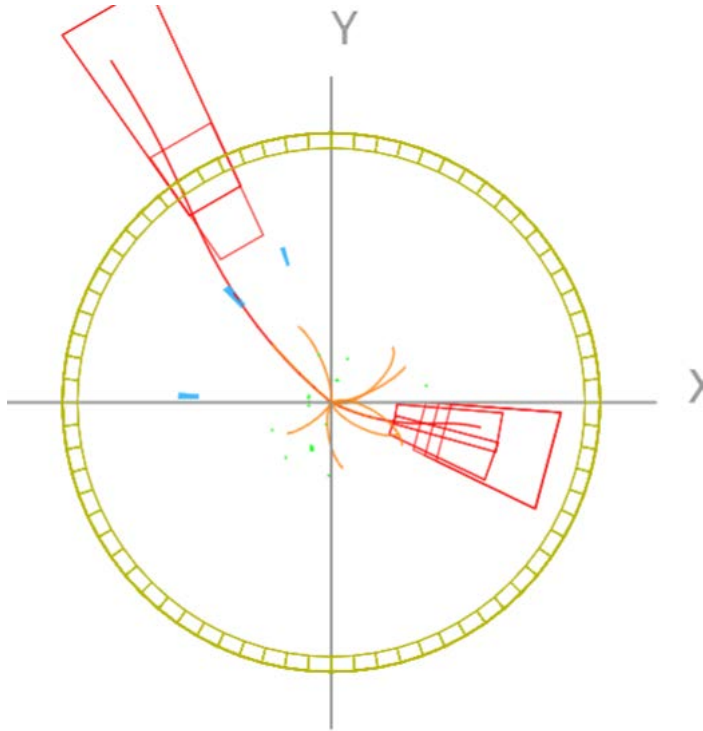

x-y view: measure  $\phi$

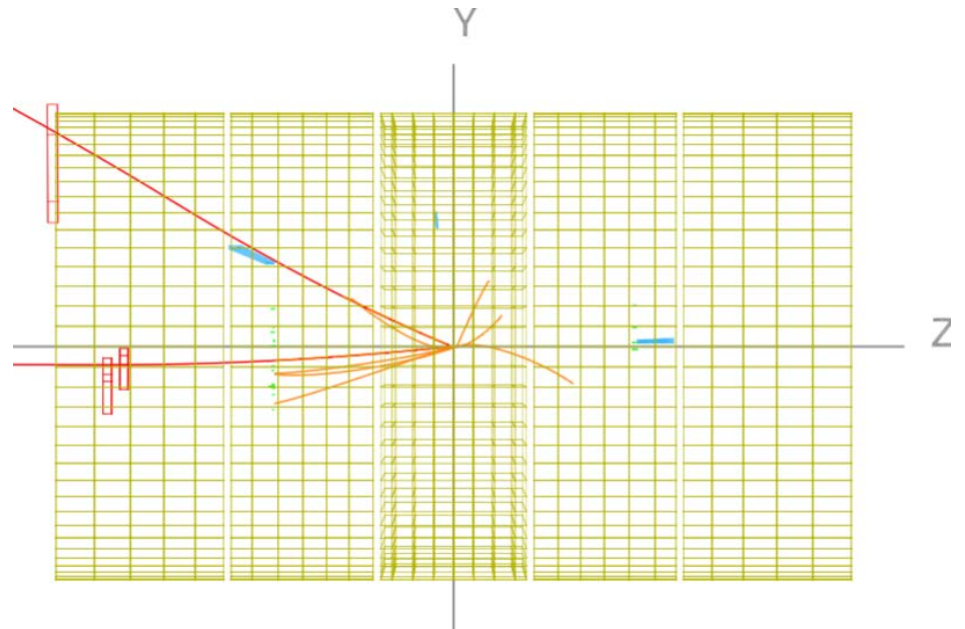

z-y view: measure  $\theta$

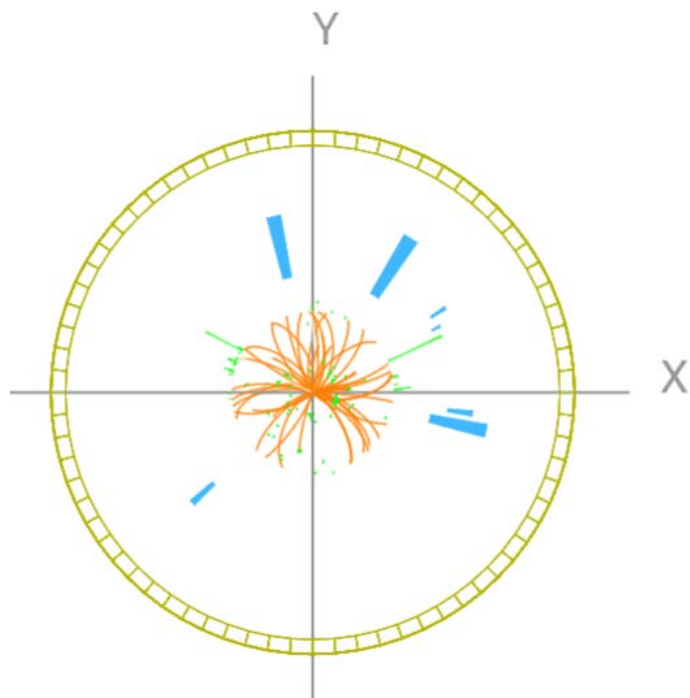

x-y view: measure  $\phi$

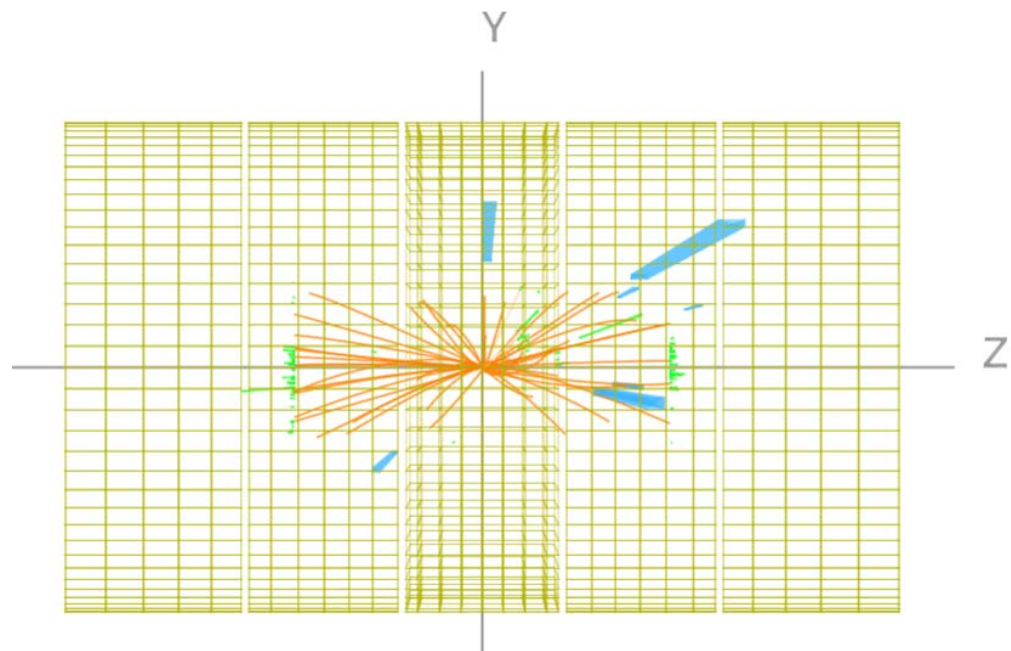

z-y view: measure  $\theta$

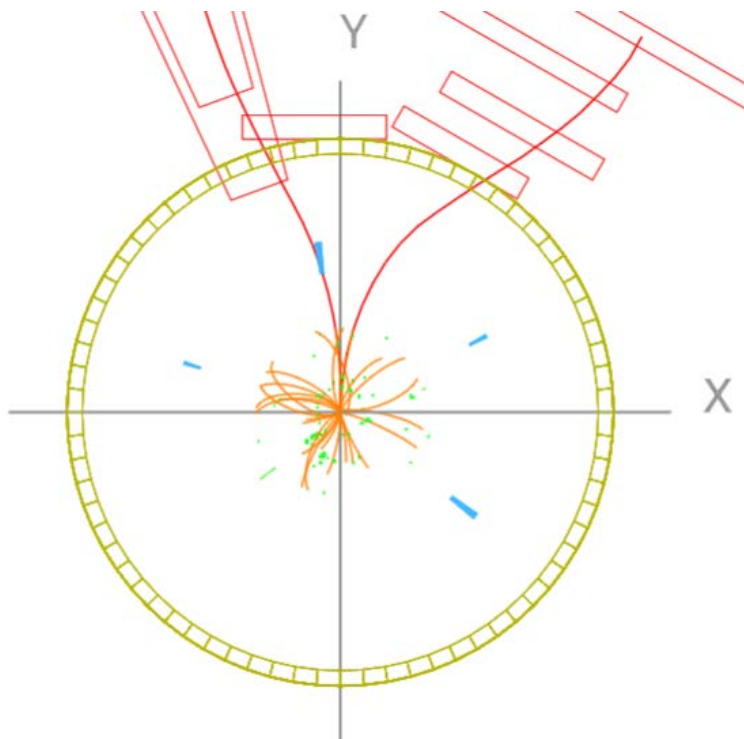

x-y view: measure  $\phi$

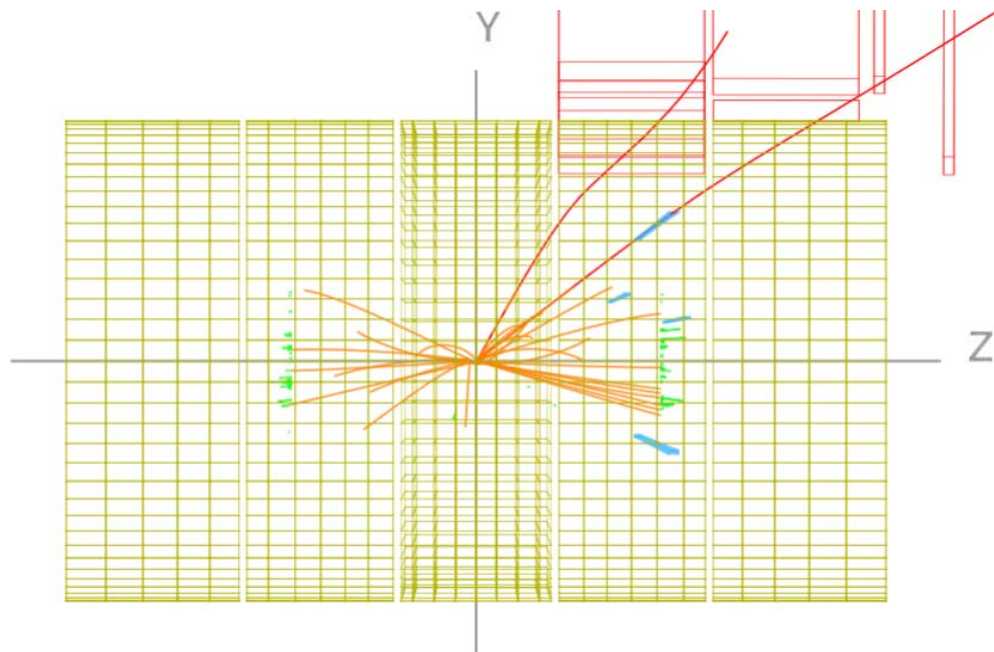

z-y view: measure  $\theta$



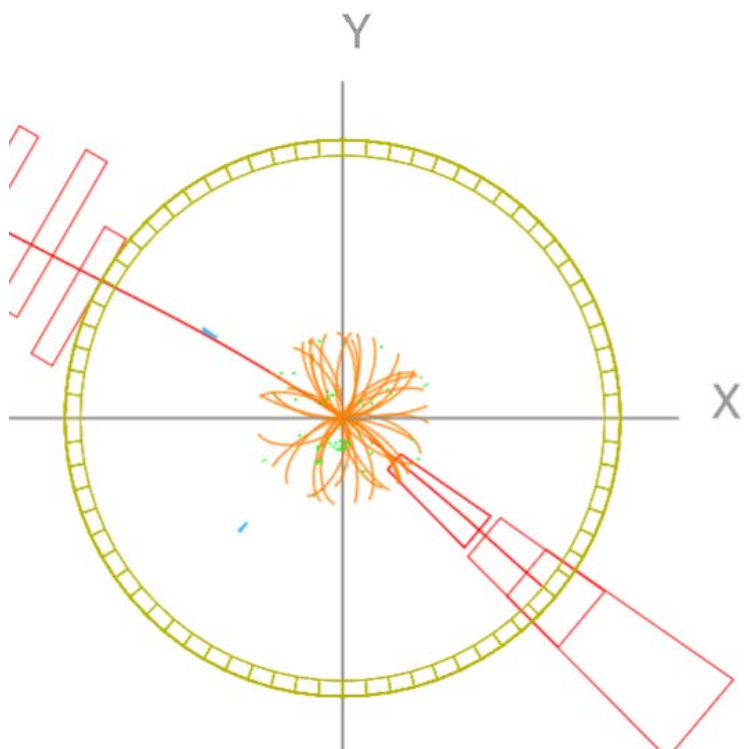

x-y view: measure  $\phi$

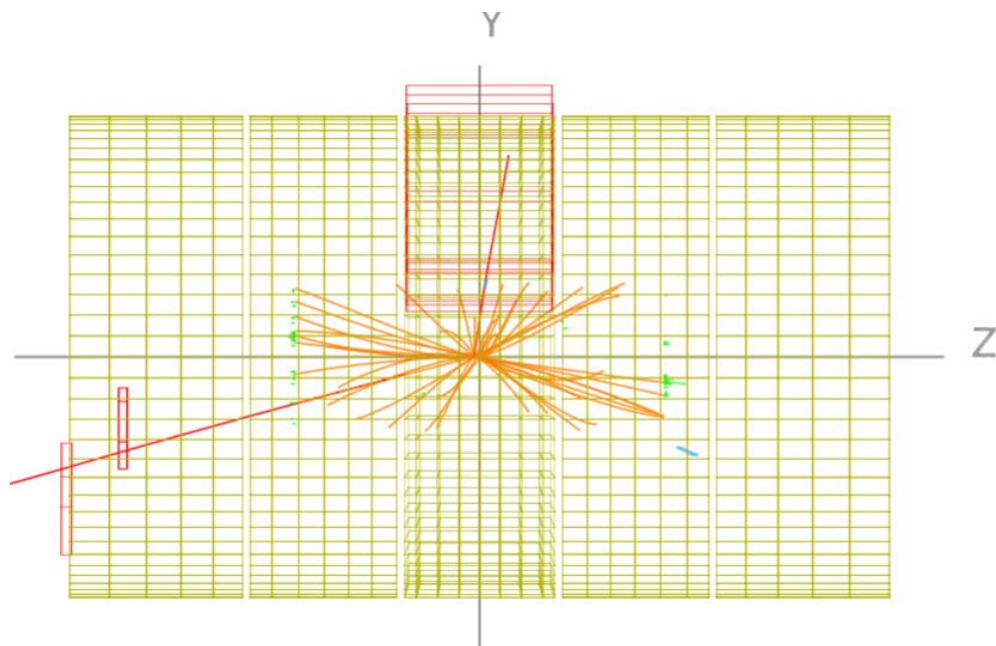

z-y view: measure  $\theta$



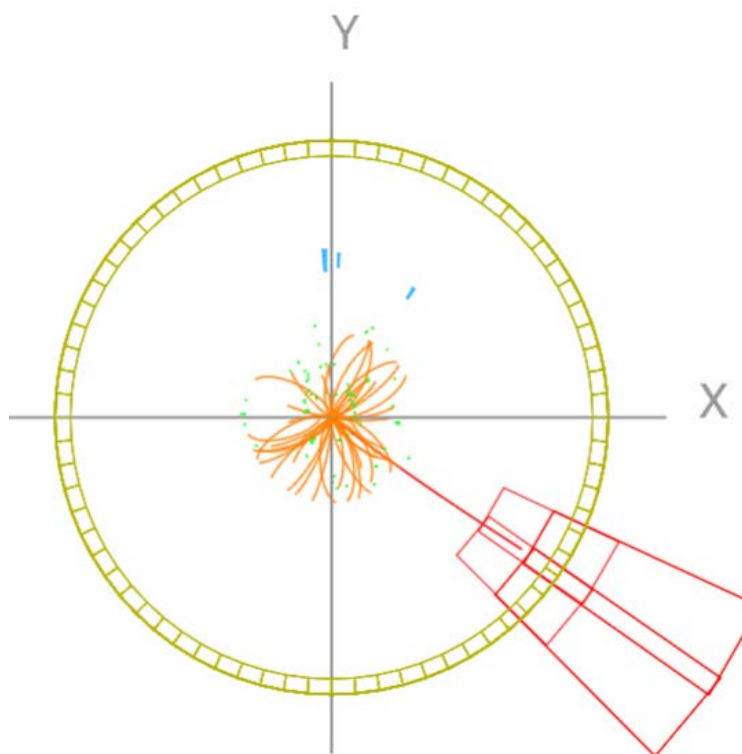

x-y view: measure  $\phi$

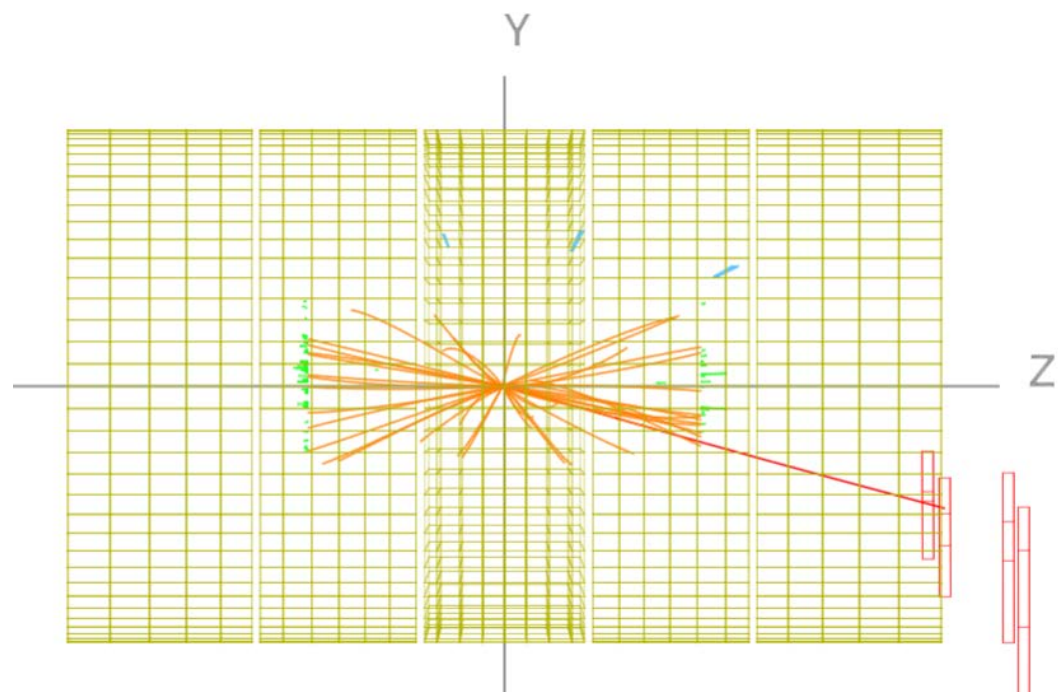

z-y view: measure  $\theta$

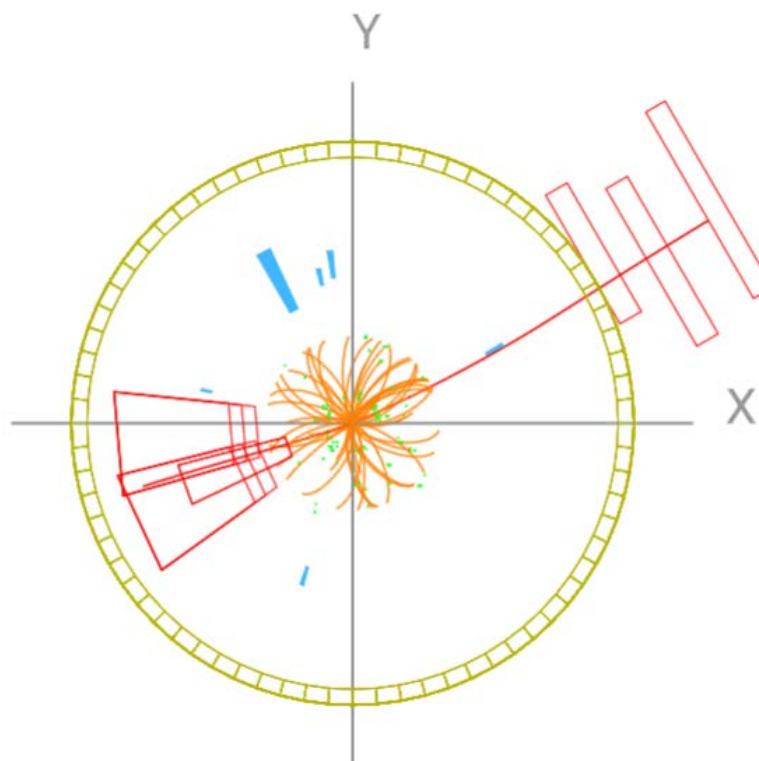

x-y view: measure  $\phi$

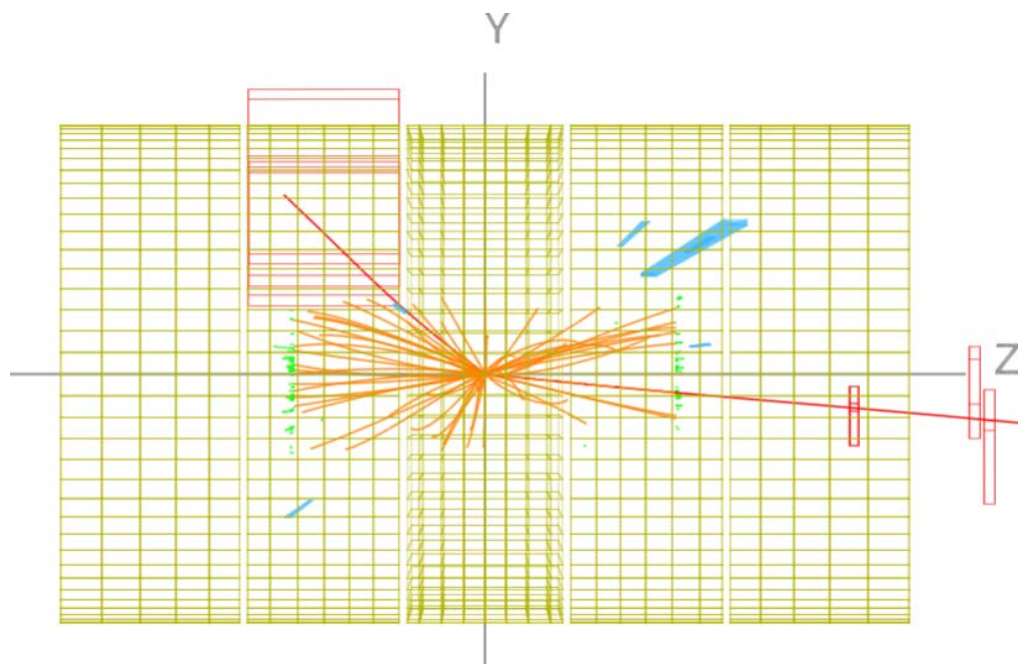

z-y view: measure  $\theta$

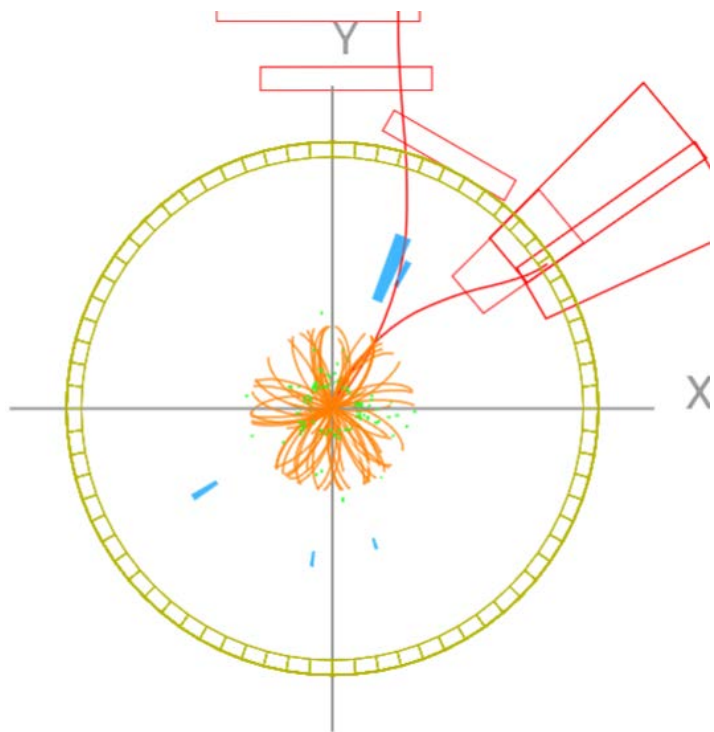

x-y view: measure  $\phi$

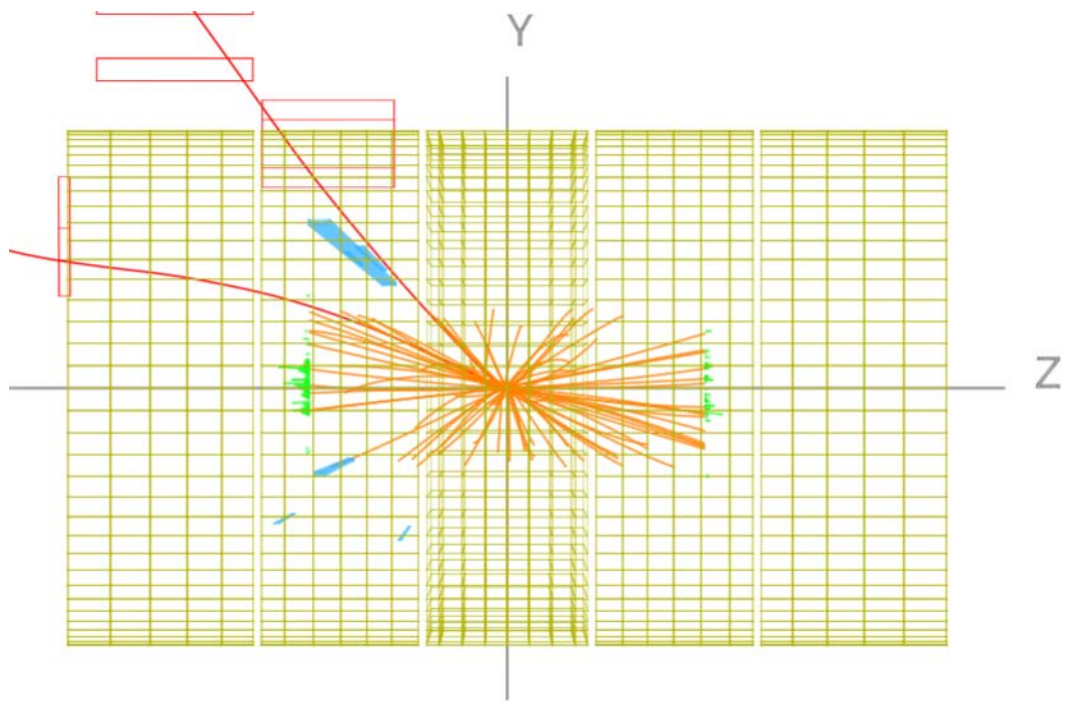

z-y view: measure  $\theta$

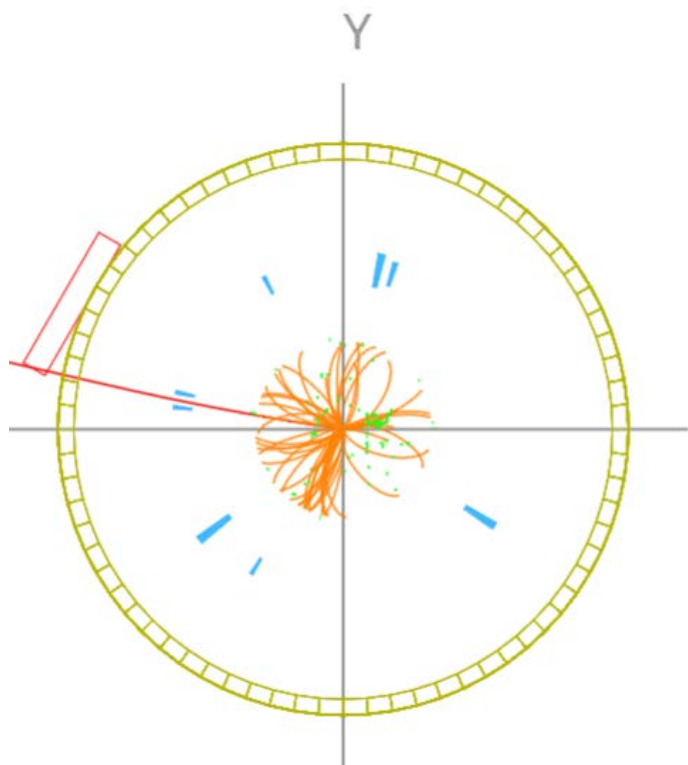

x-y view: measure  $\phi$

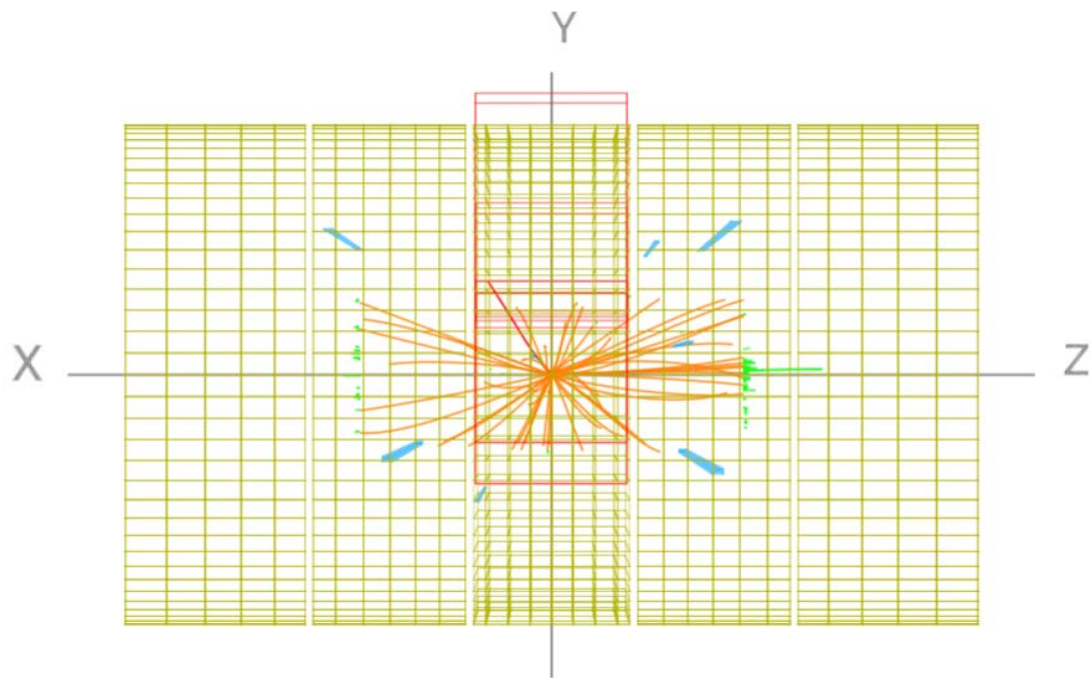

z-y view: measure  $\theta$



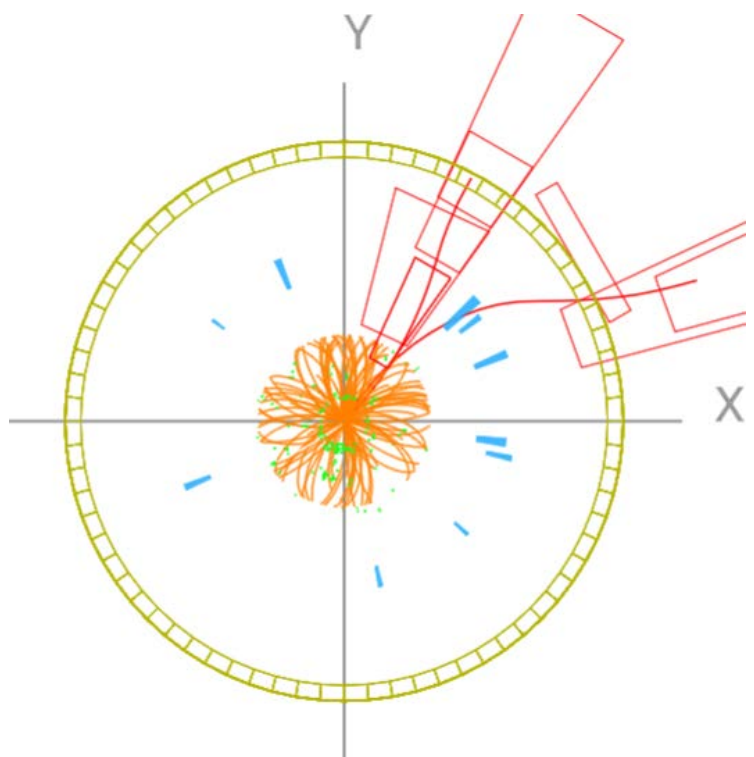

x-y view: measure  $\phi$

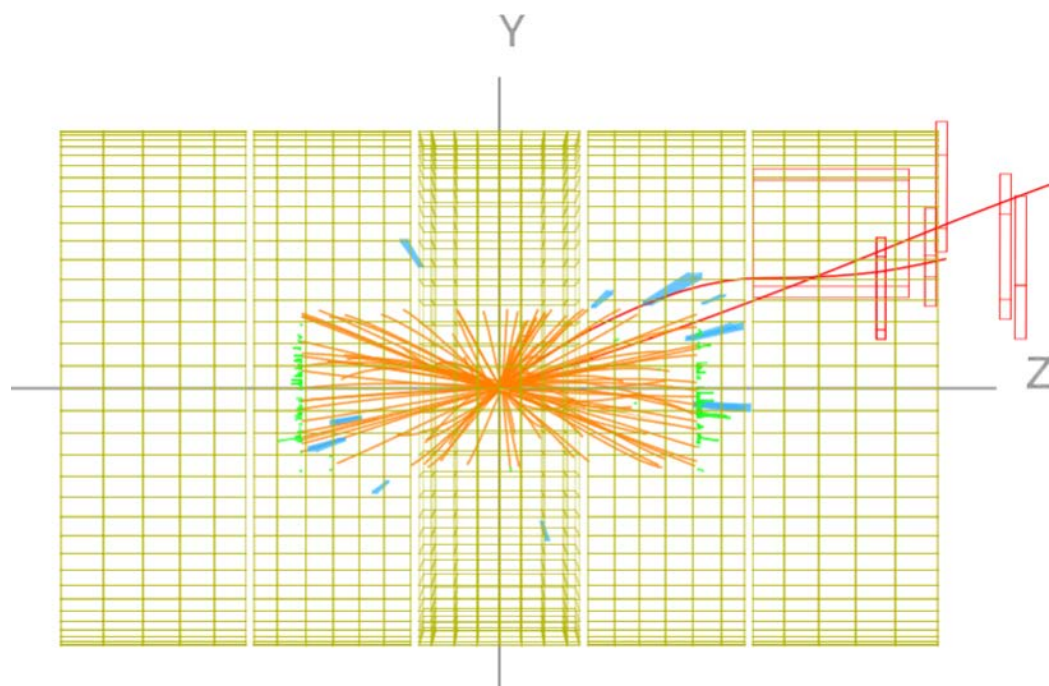

z-y view: measure  $\theta$

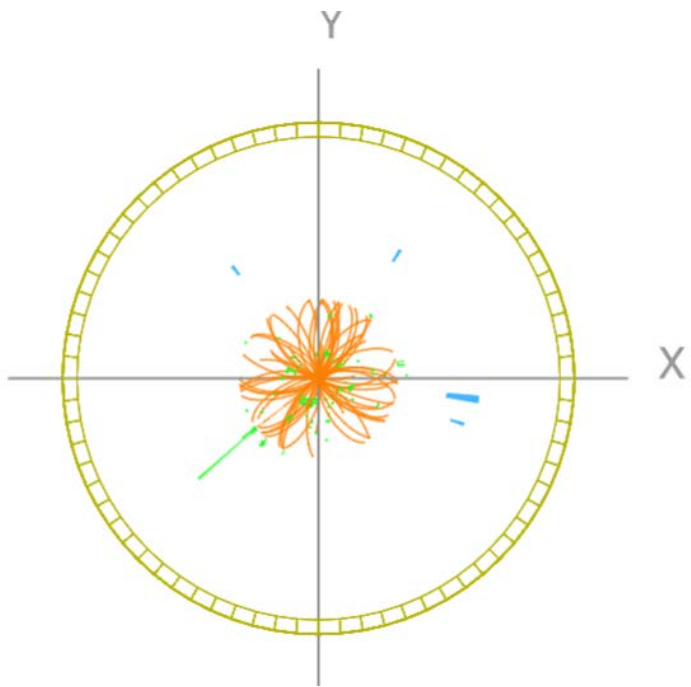

x-y view: measure  $\phi$

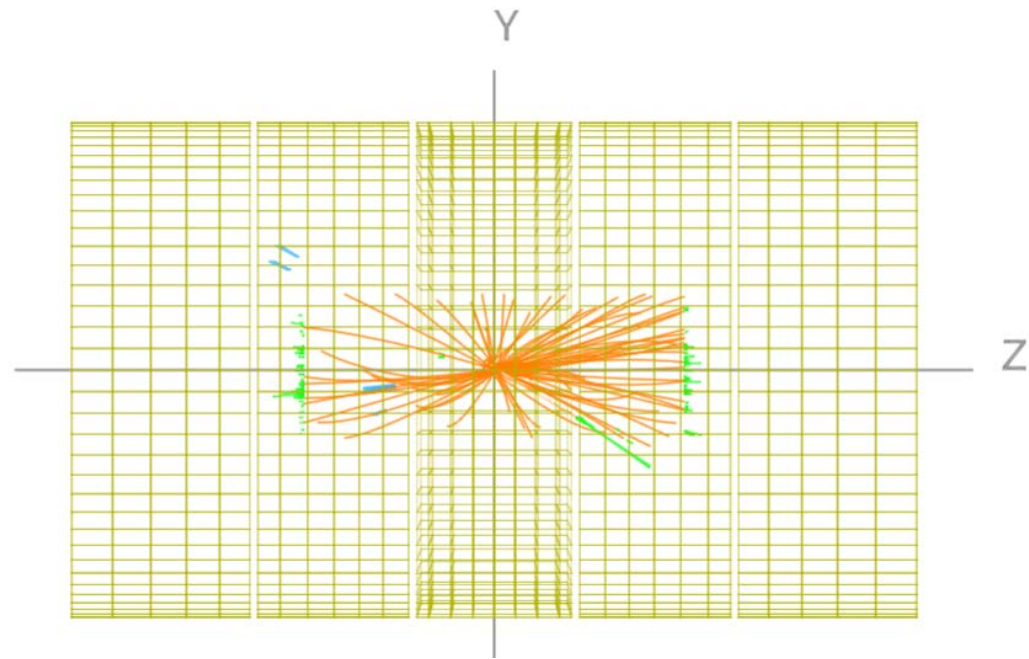

z-y view: measure  $\theta$



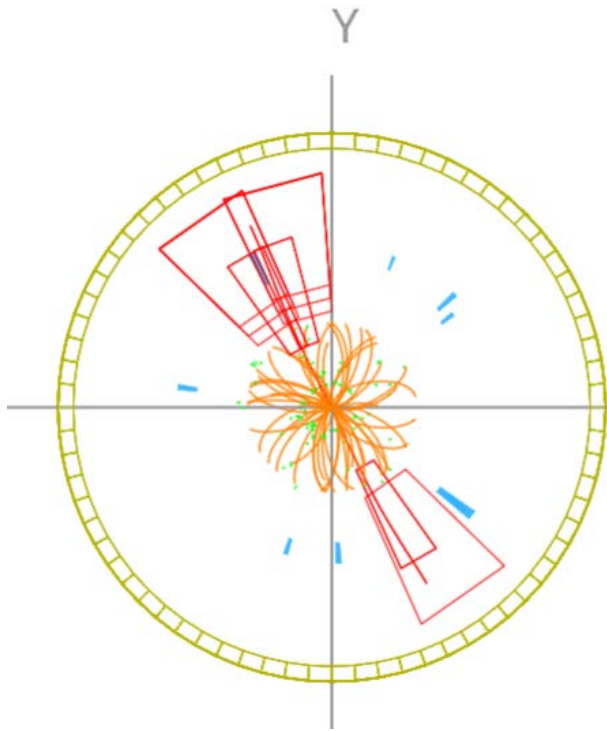

x-y view: measure  $\phi$

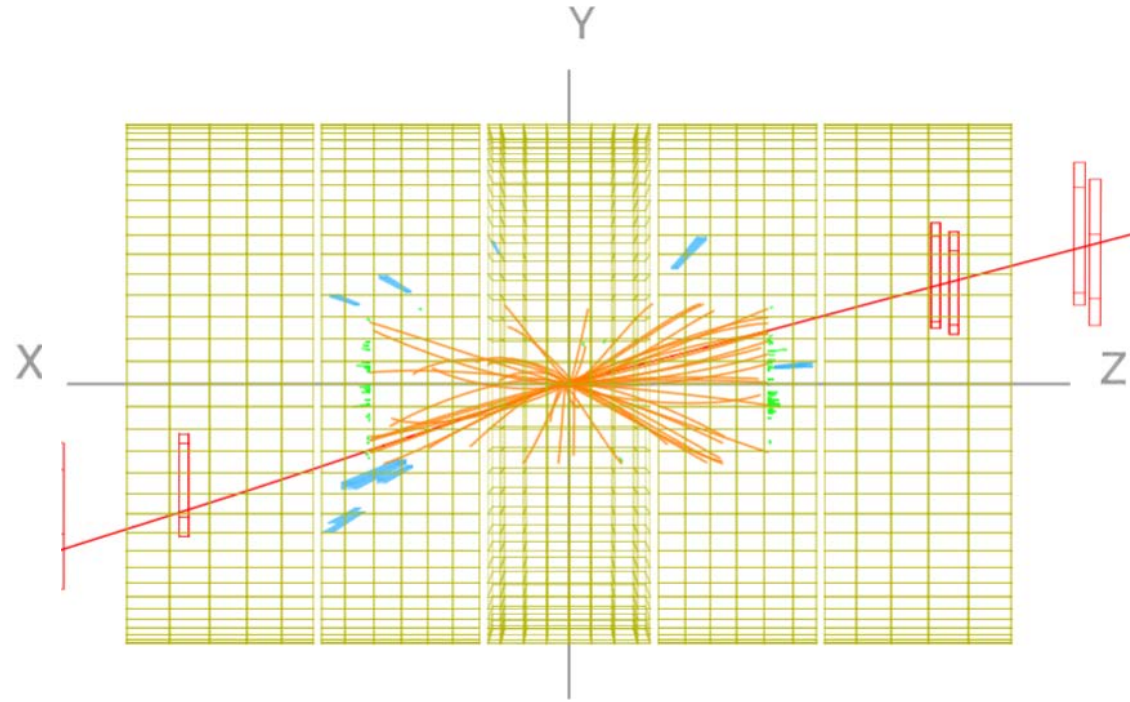

z-y view: measure  $\theta$

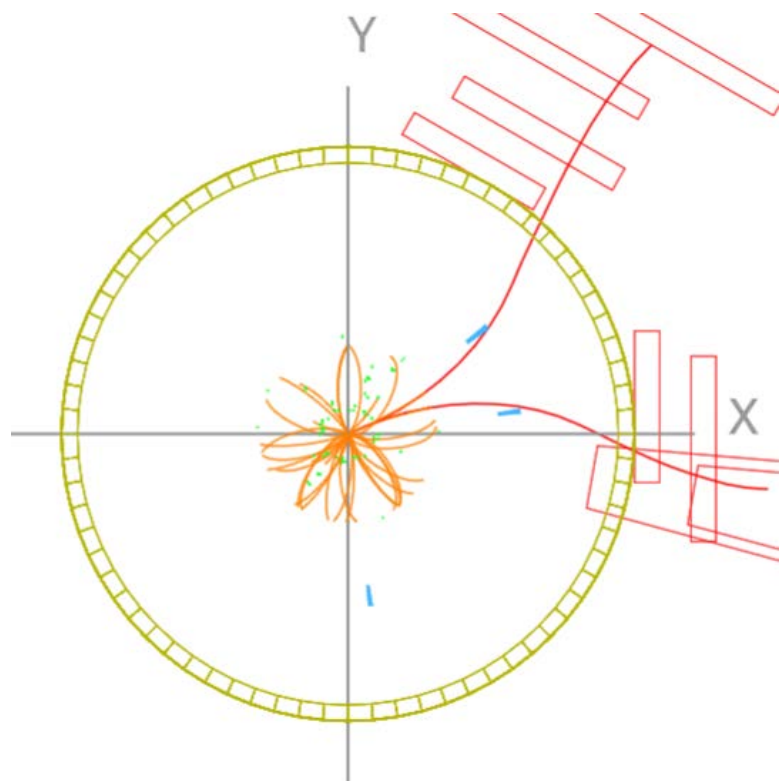

x-y view: measure  $\phi$

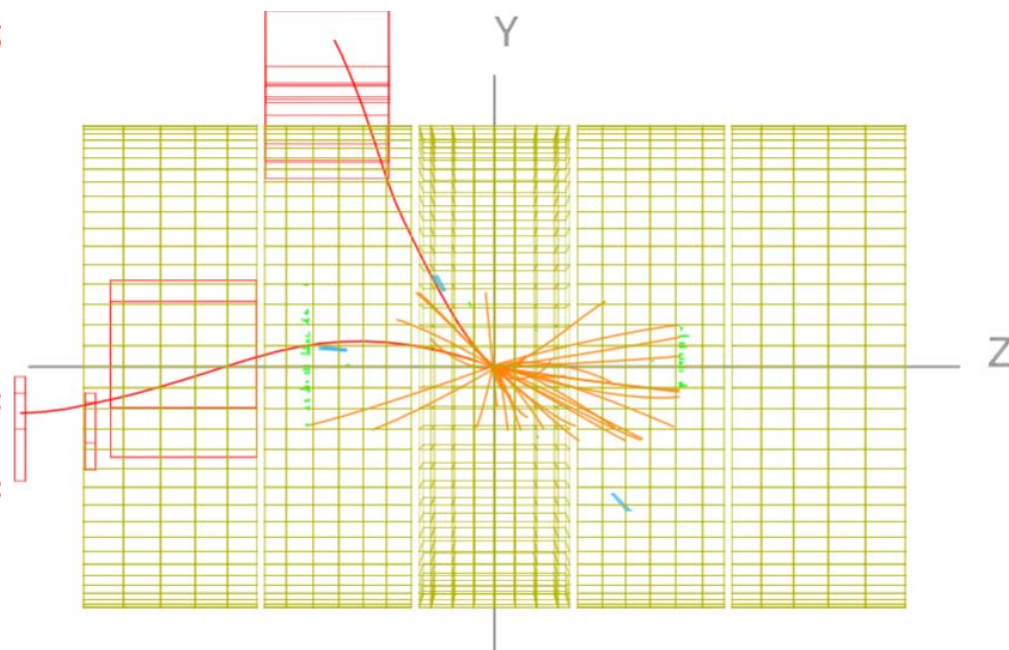

z-y view: measure  $\theta$

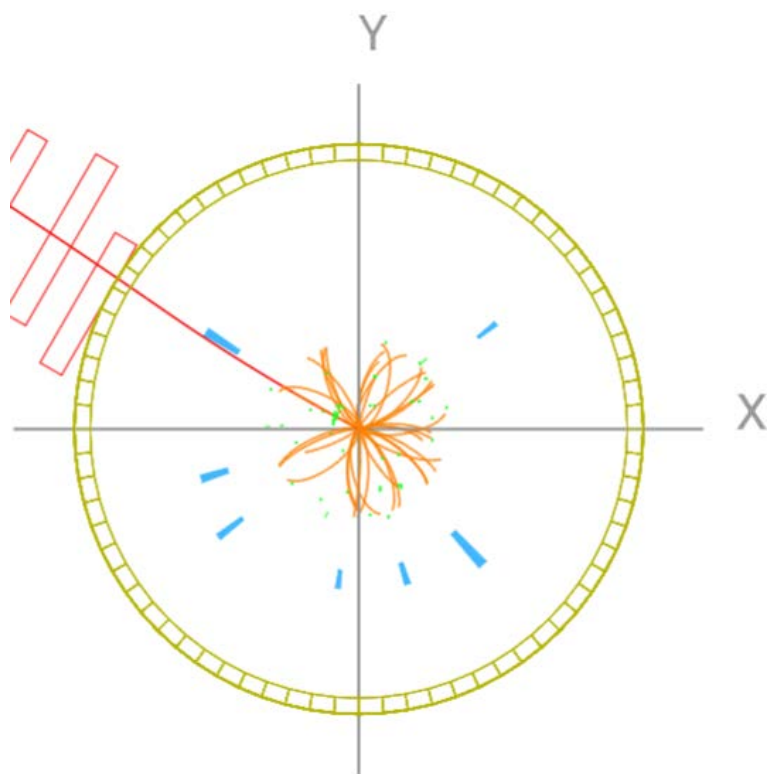

x-y view: measure  $\phi$

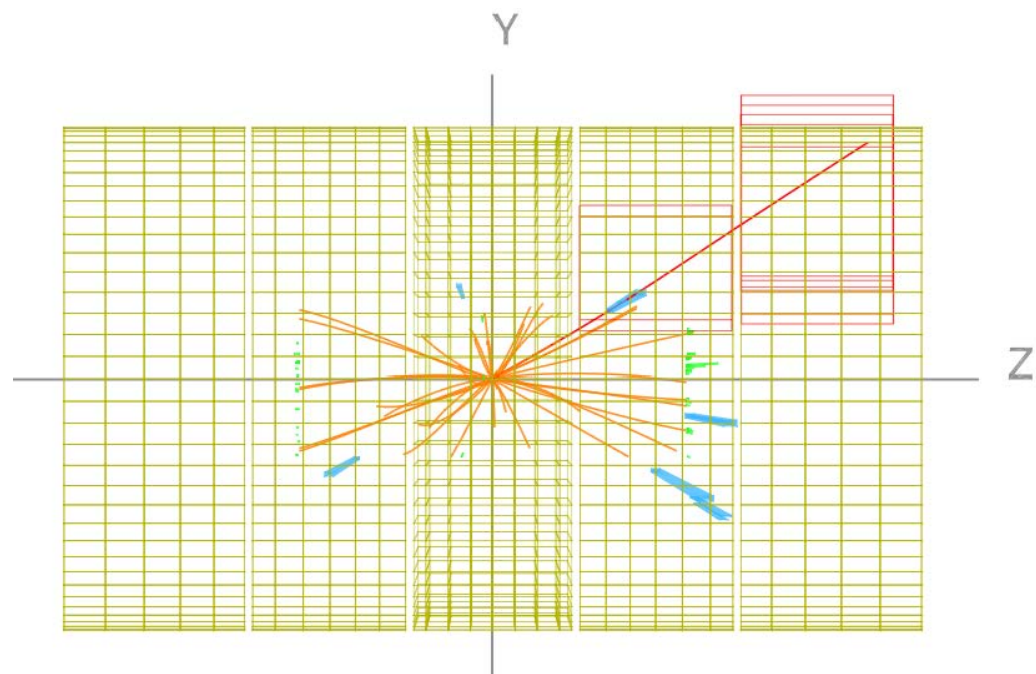

z-y view: measure  $\theta$

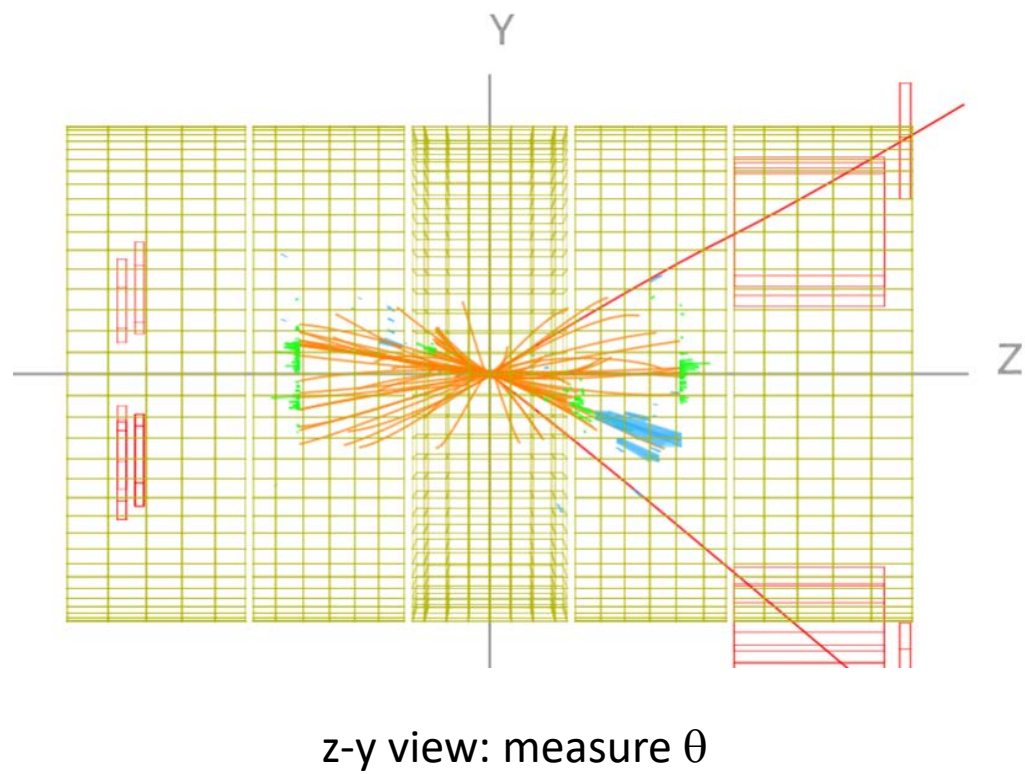
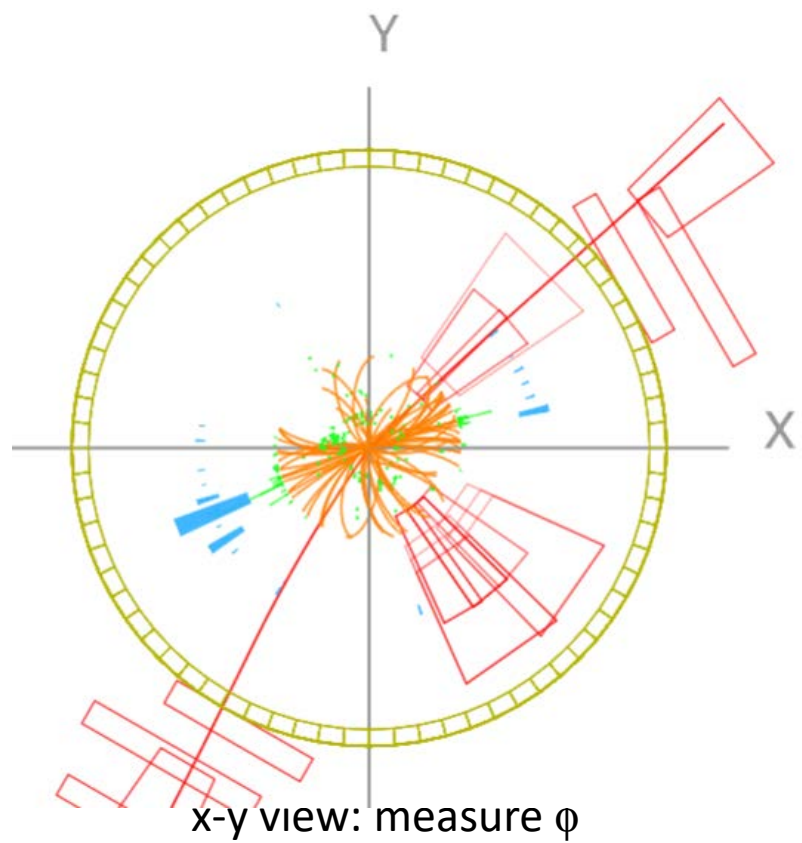



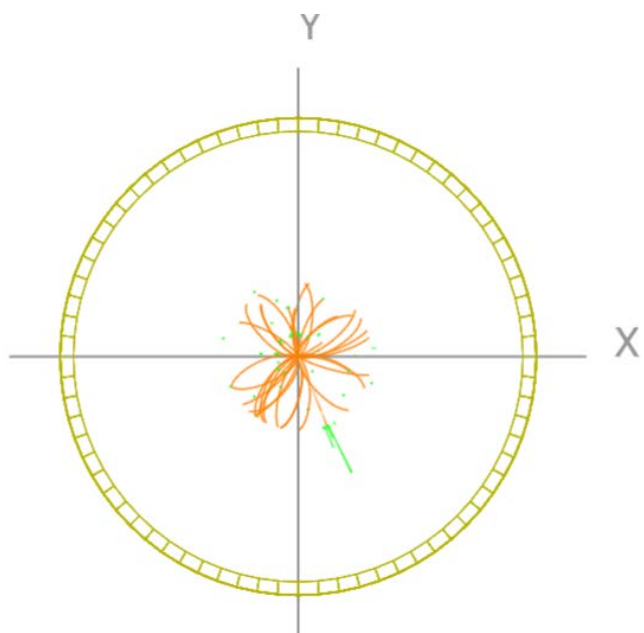

x-y view: measure  $\phi$

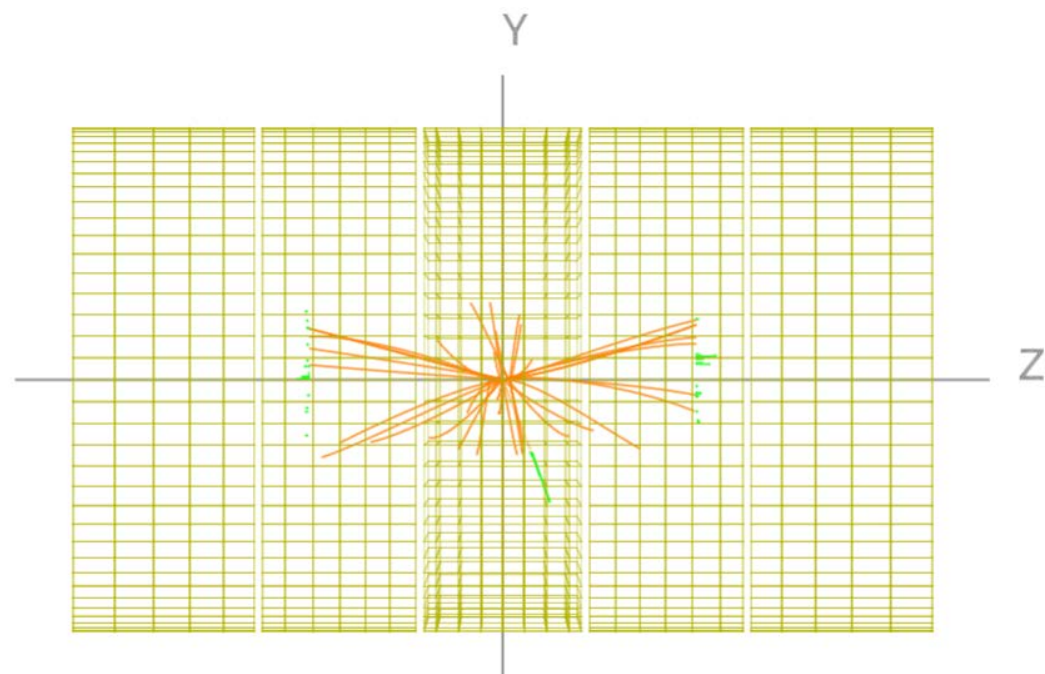

z-y view: measure  $\theta$



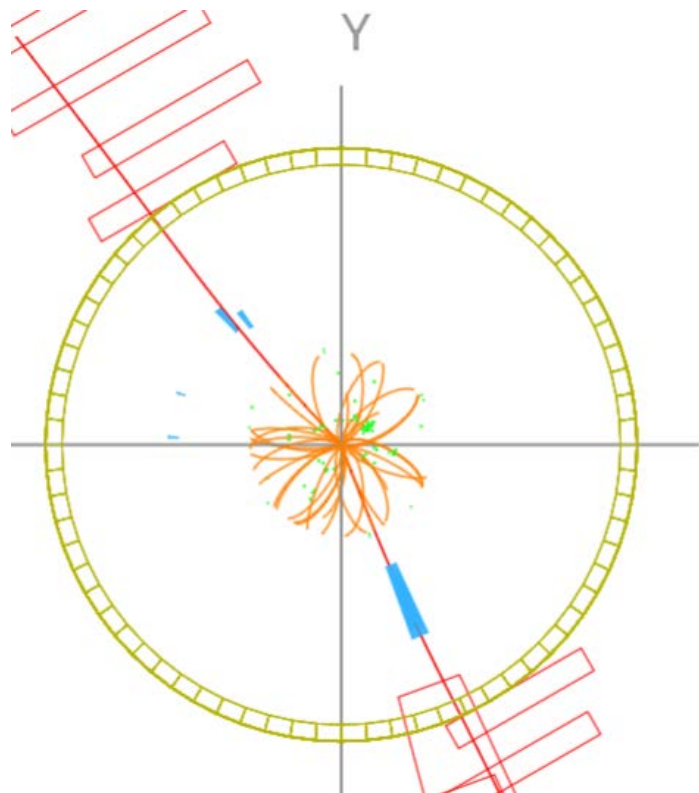

x-y view: measure  $\phi$

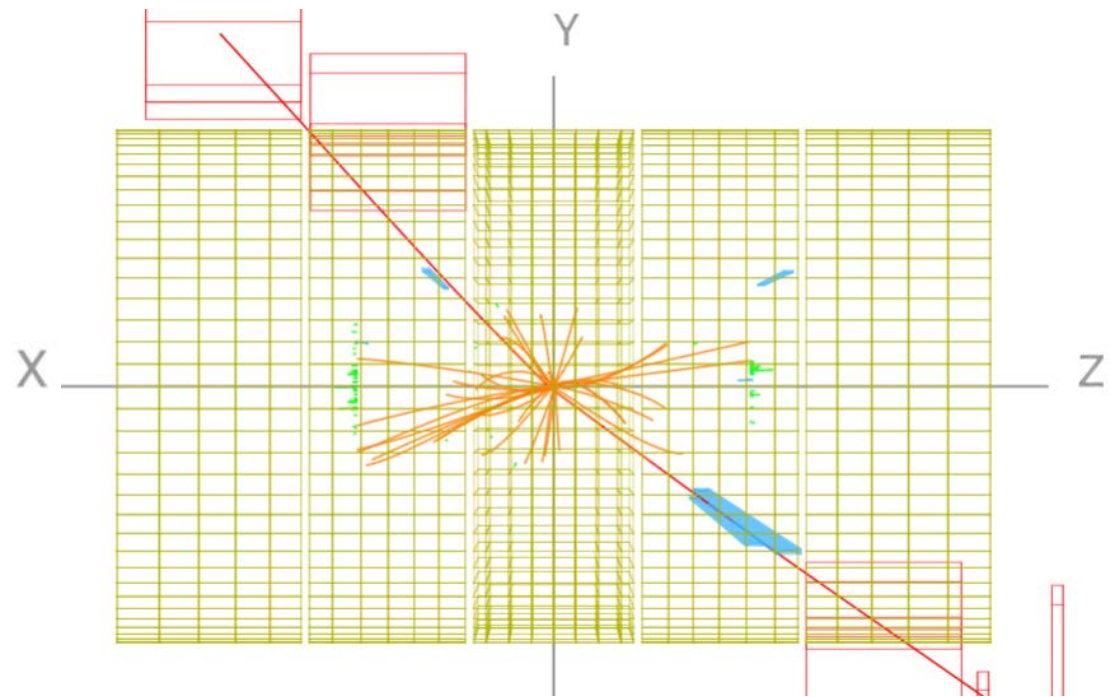

z-y view: measure  $\theta$

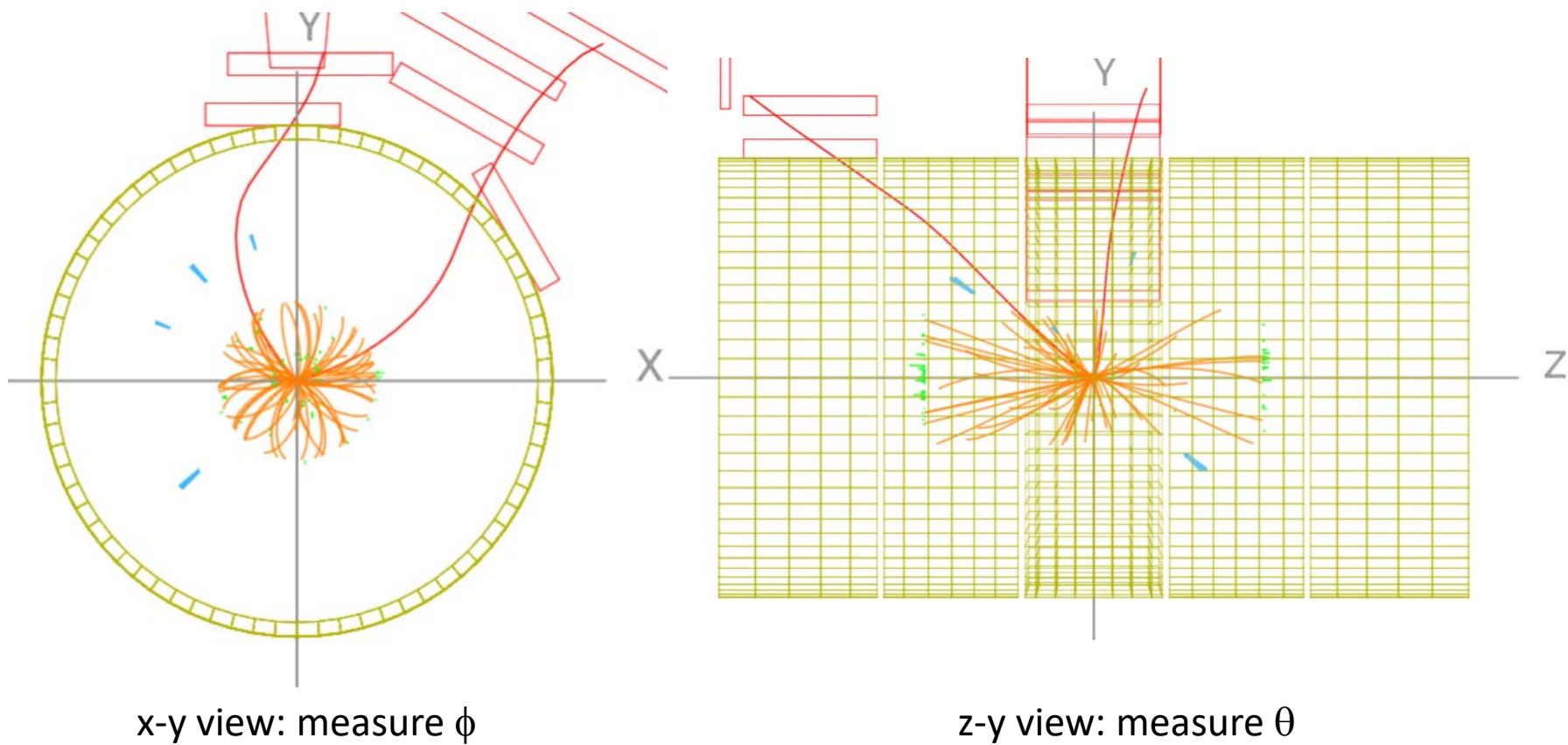

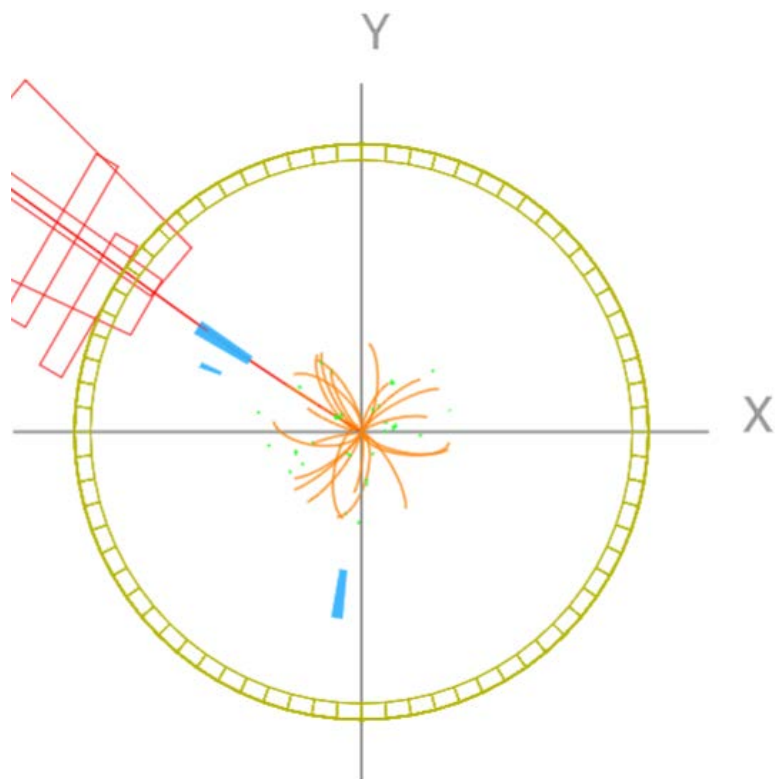

x-y view: measure  $\phi$

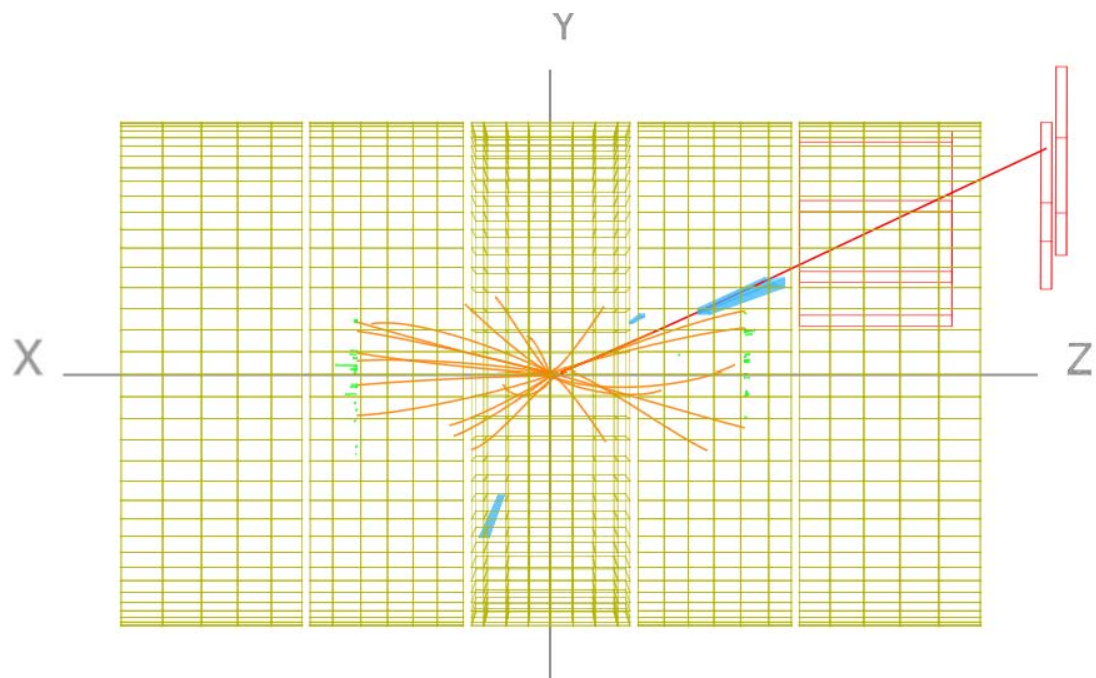

z-y view: measure  $\theta$

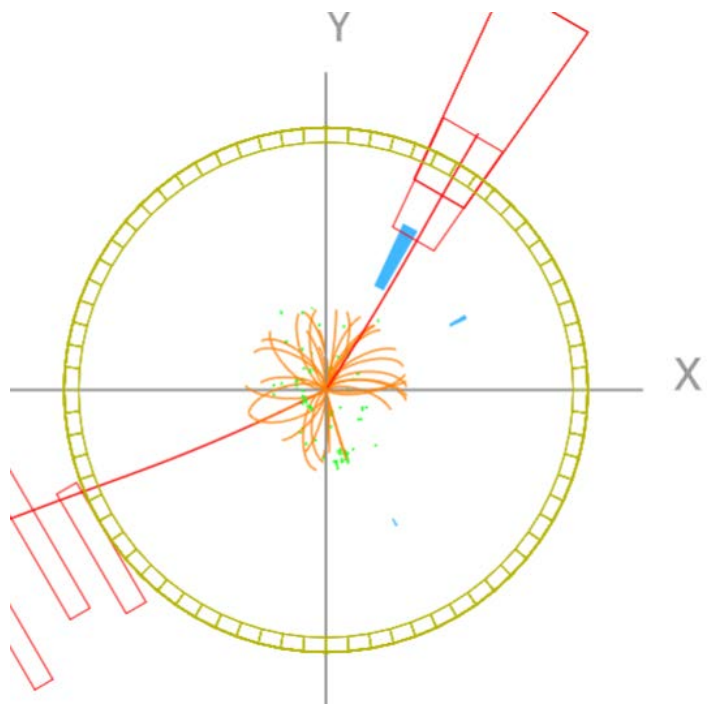

x-y view: measure  $\phi$

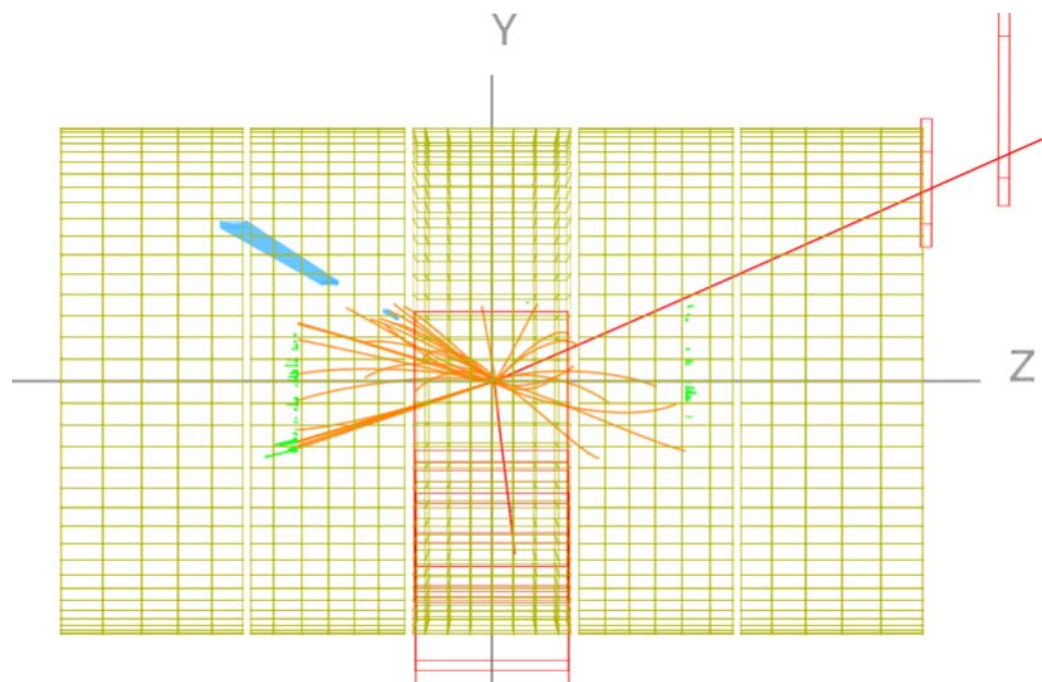

z-y view: measure  $\theta$



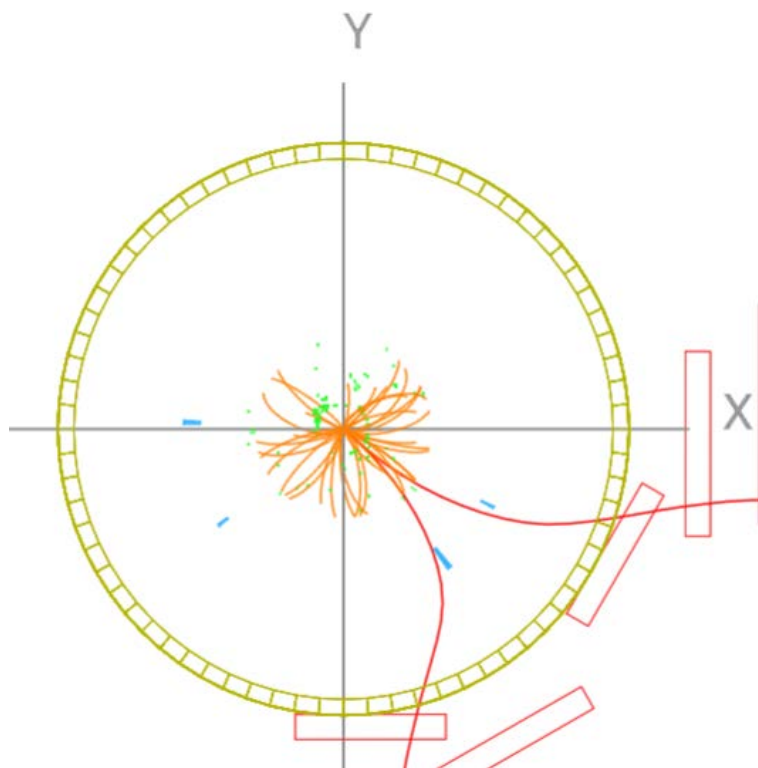

x-y view: measure  $\phi$

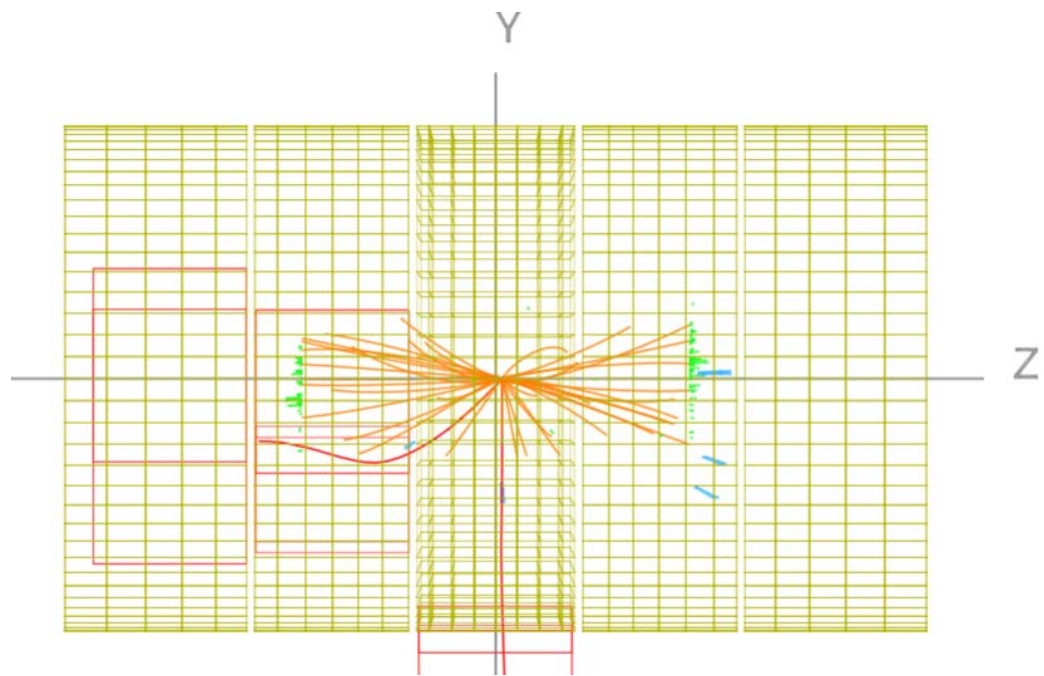

z-y view: measure  $\theta$



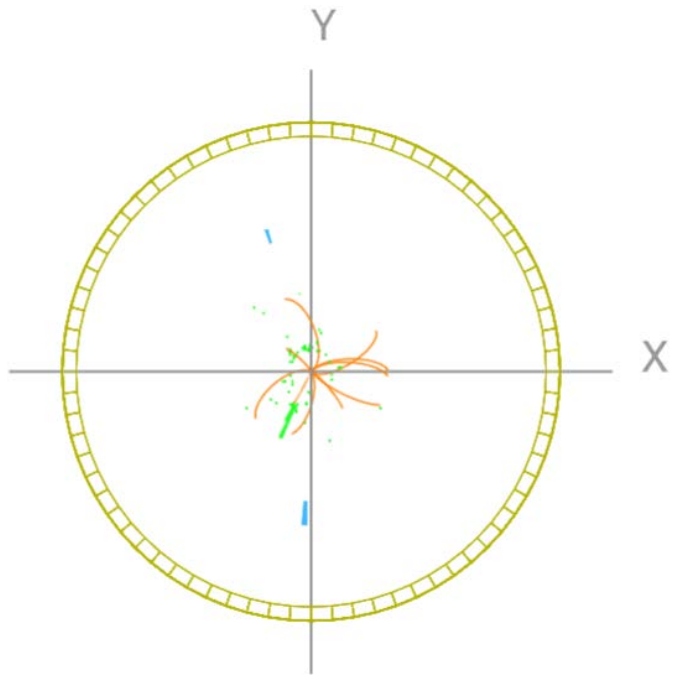

x-y view: measure  $\phi$

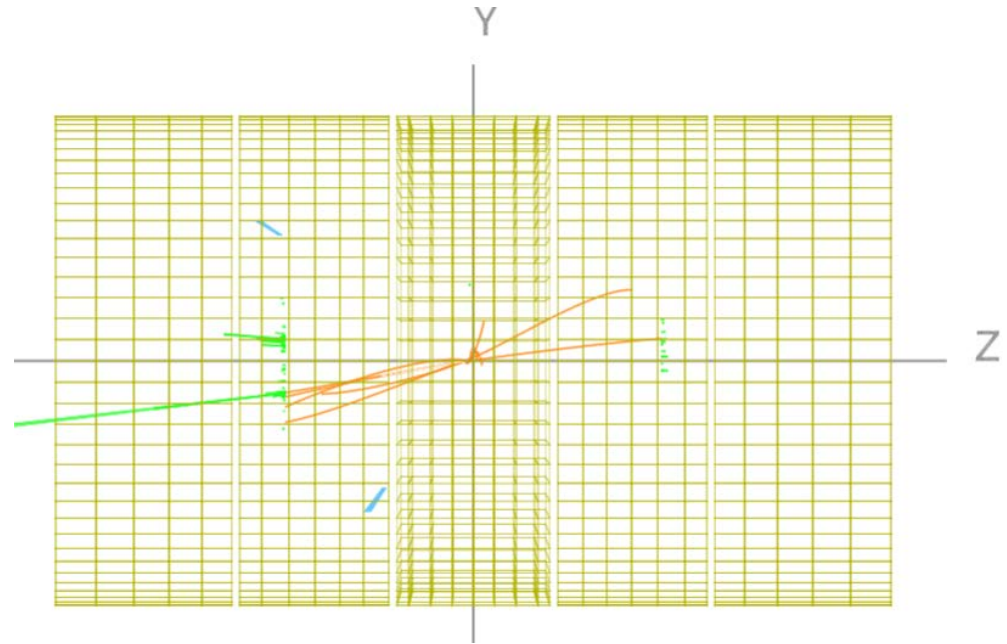

z-y view: measure  $\theta$

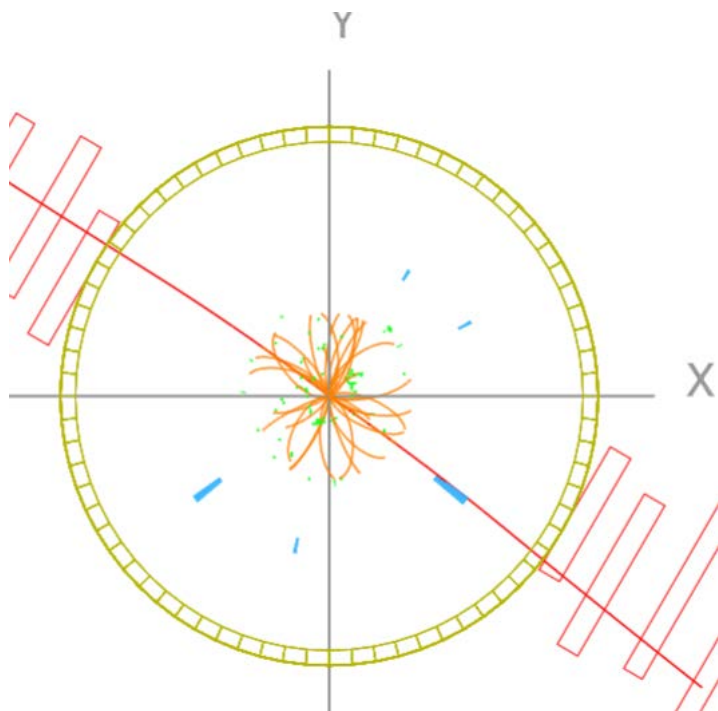

x-y view: measure  $\phi$

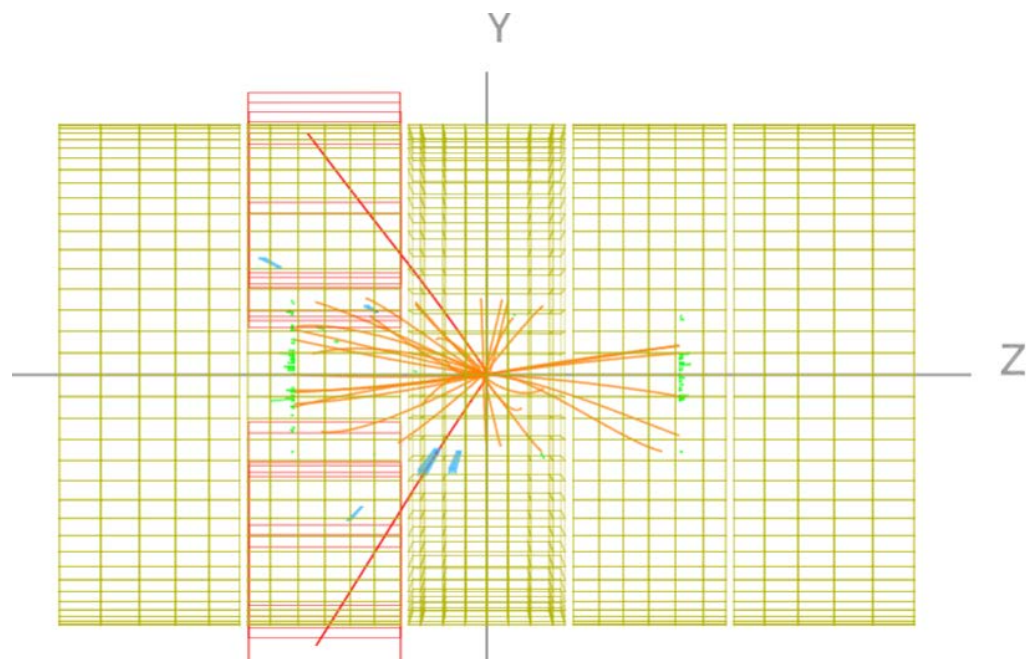

z-y view: measure  $\theta$

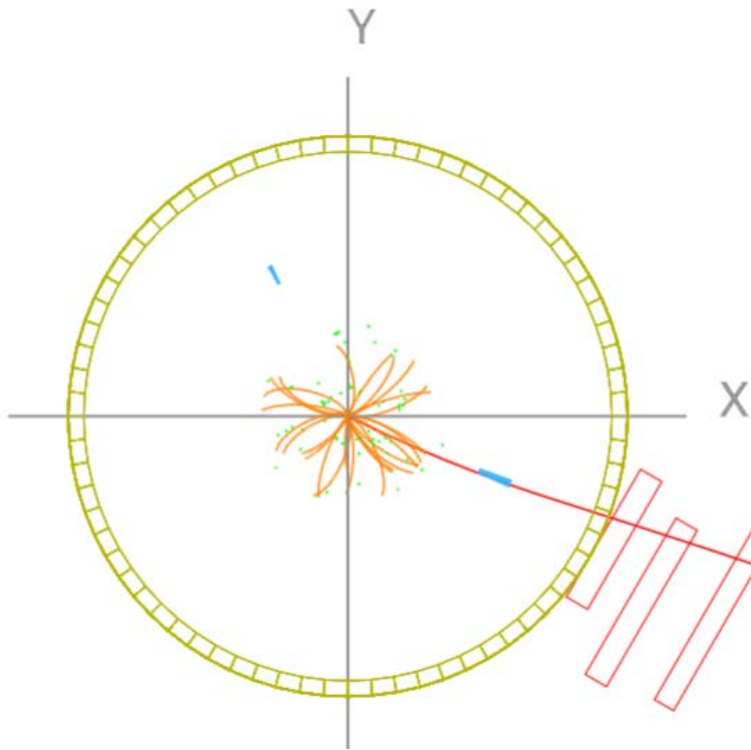

x-y view: measure  $\phi$

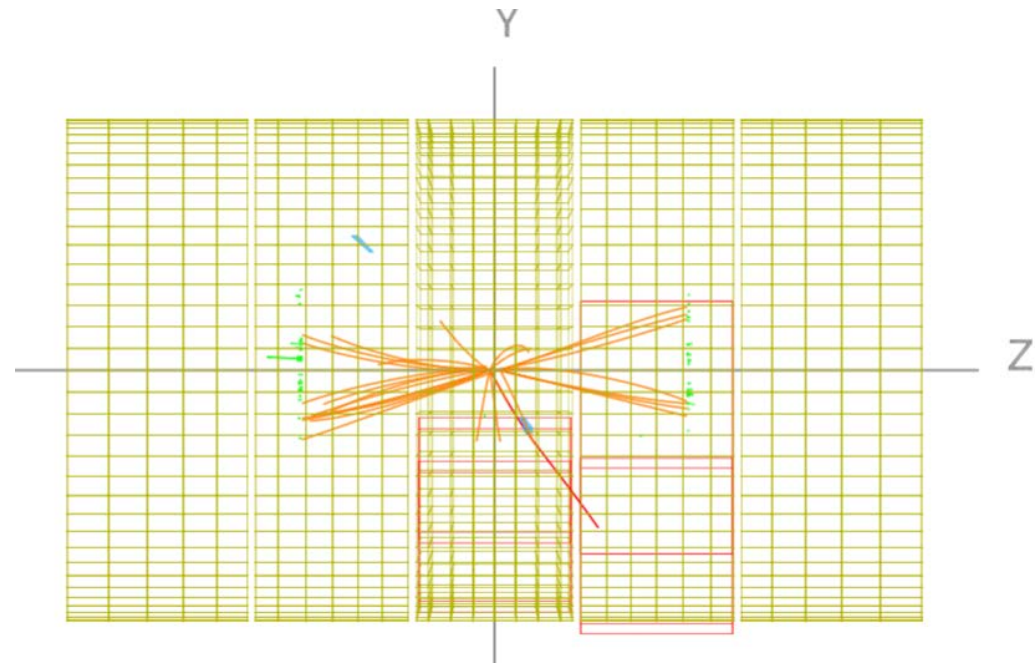

z-y view: measure  $\theta$

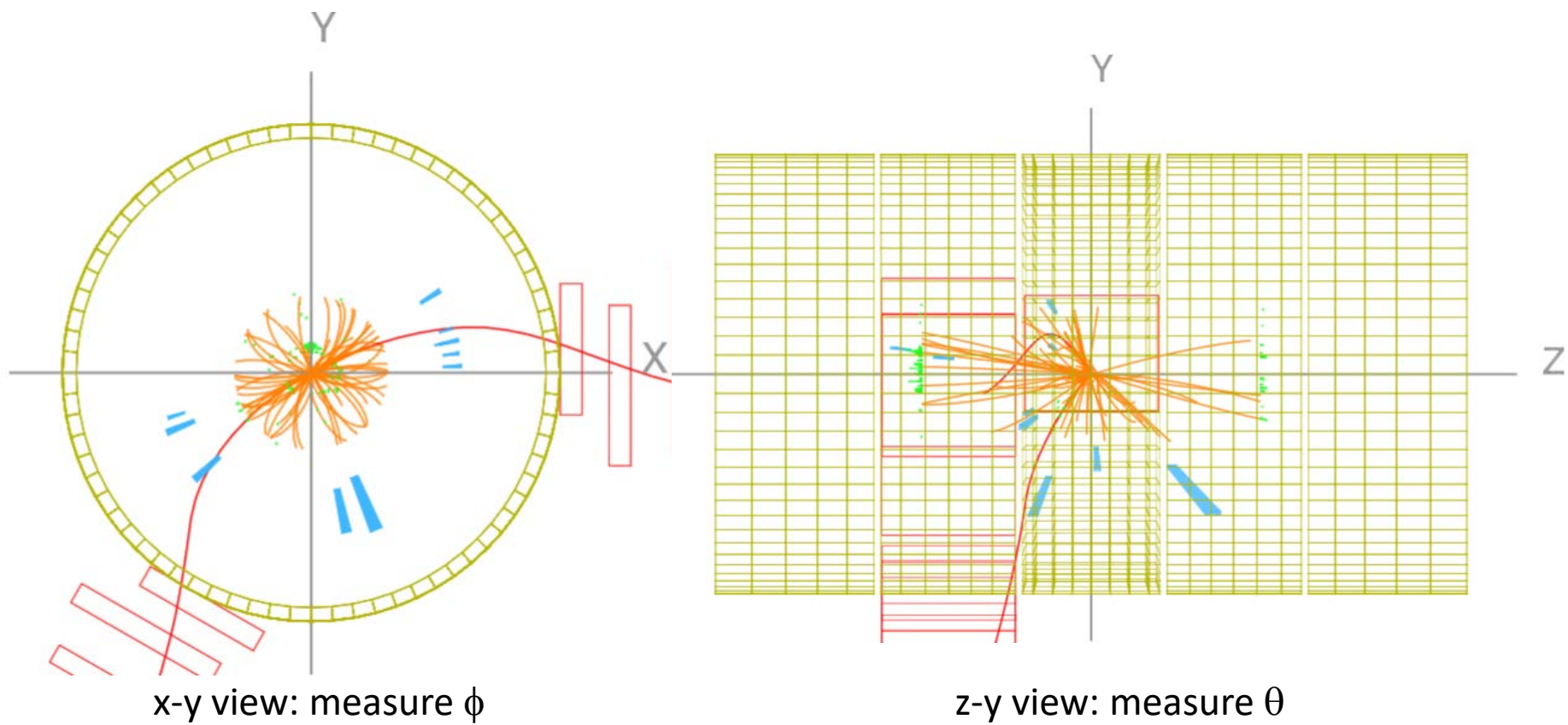

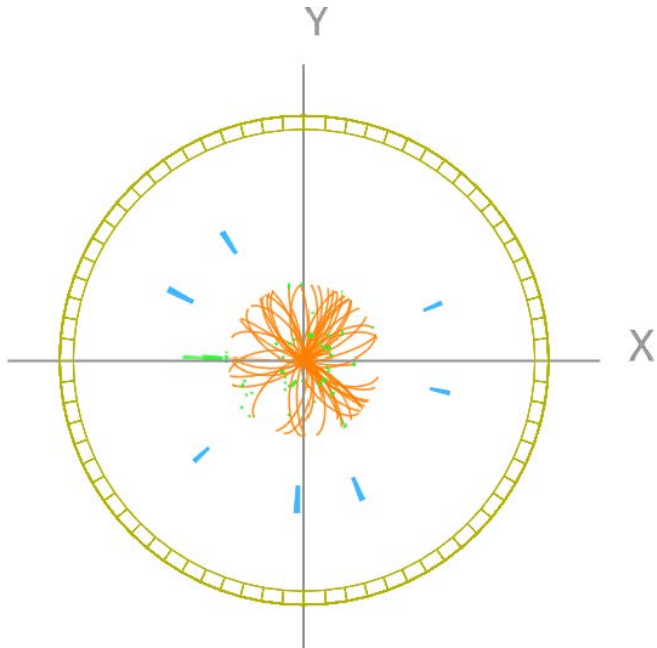

x-y view: measure  $\phi$

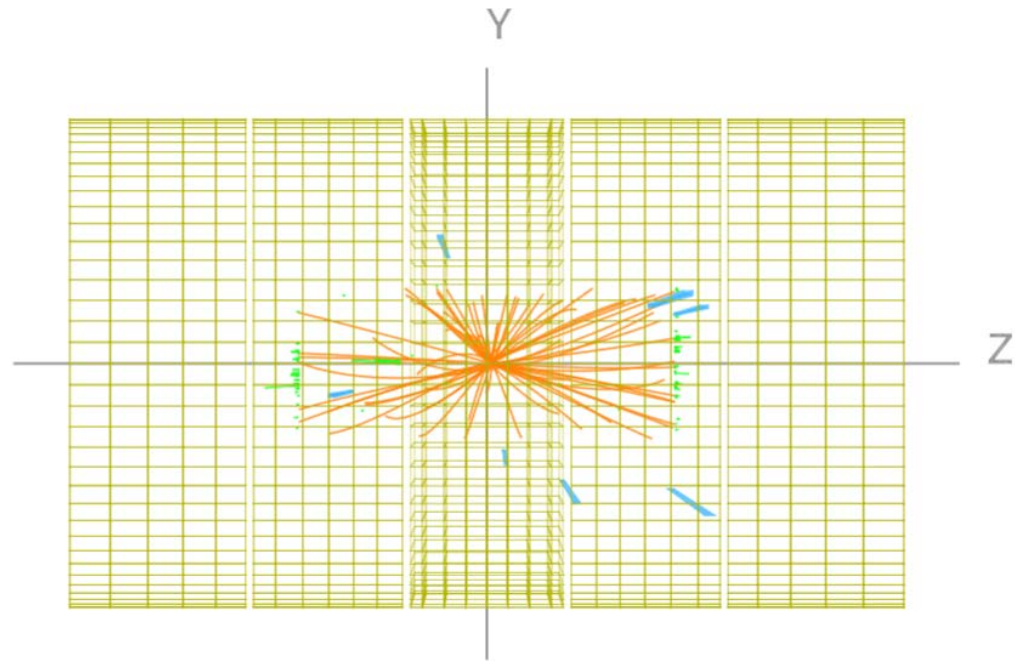

z-y view: measure  $\theta$



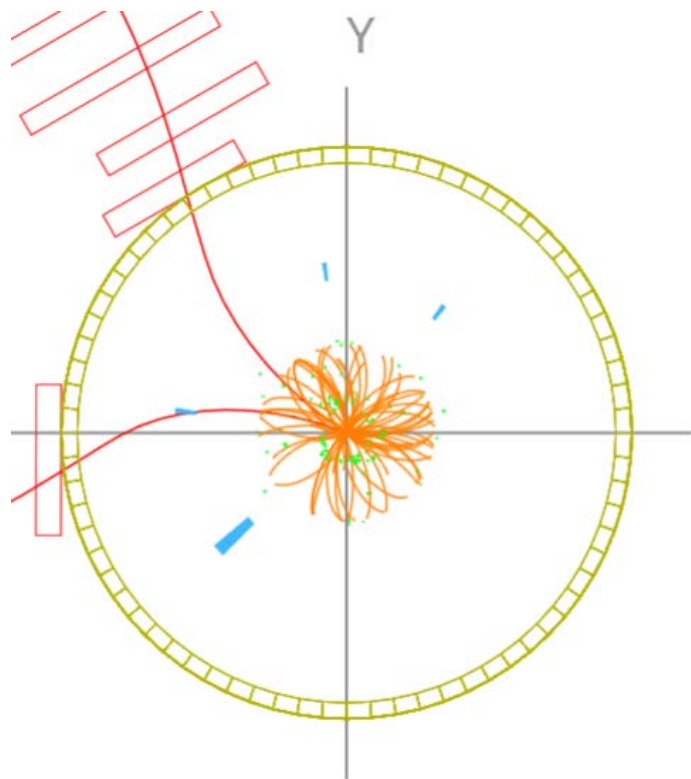

x-y view: measure  $\phi$

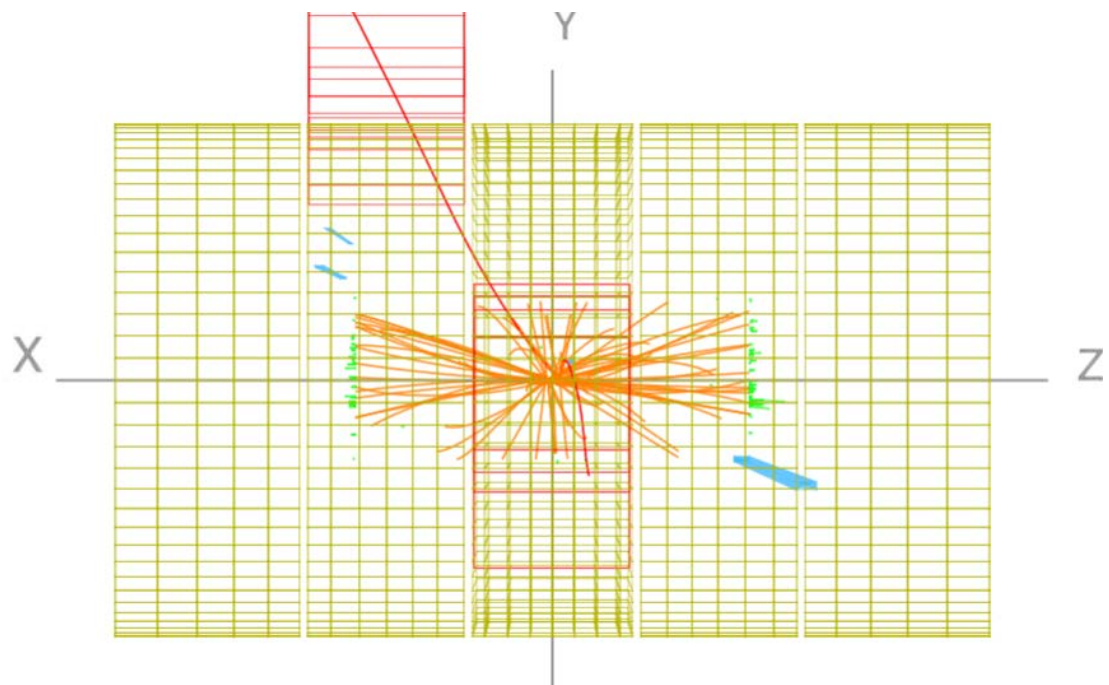

z-y view: measure  $\theta$

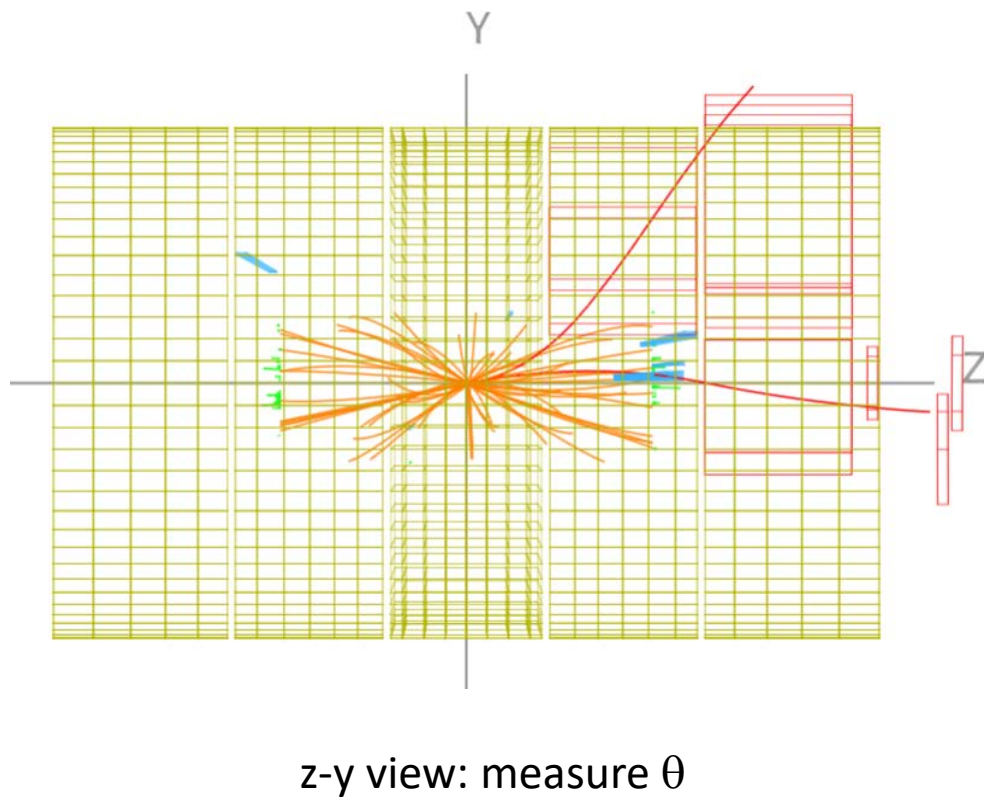
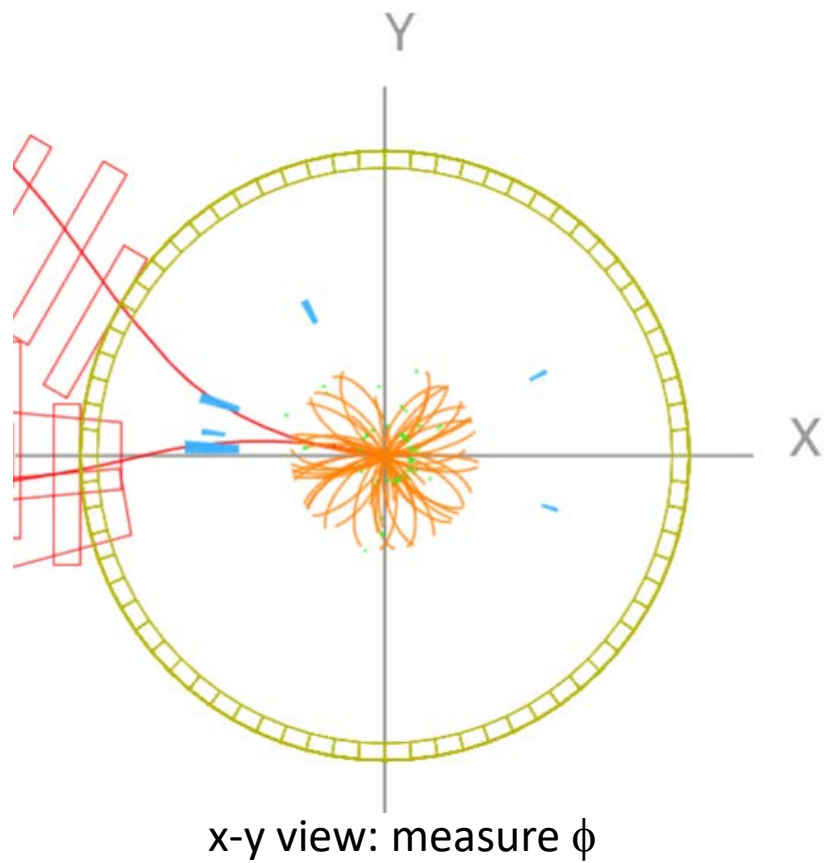

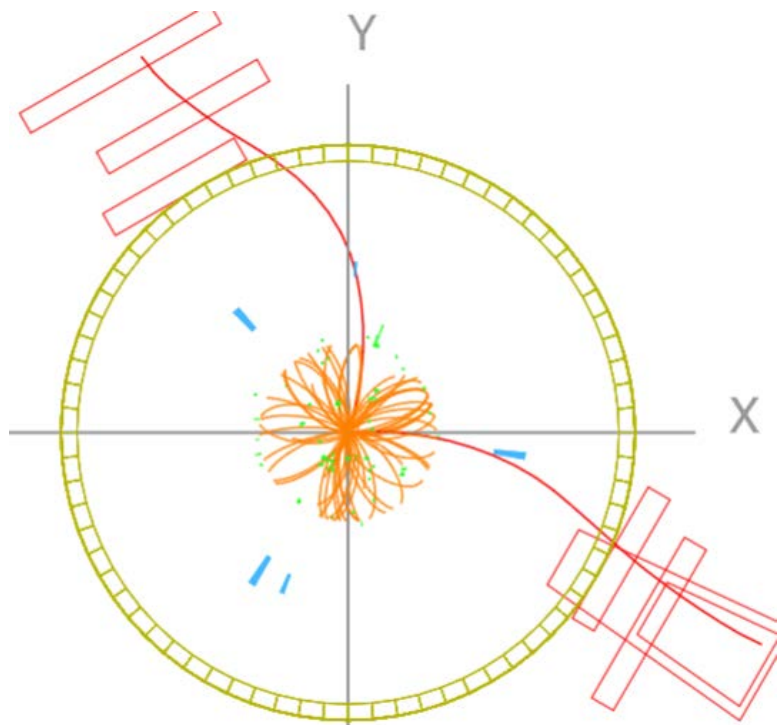

x-y view: measure  $\phi$

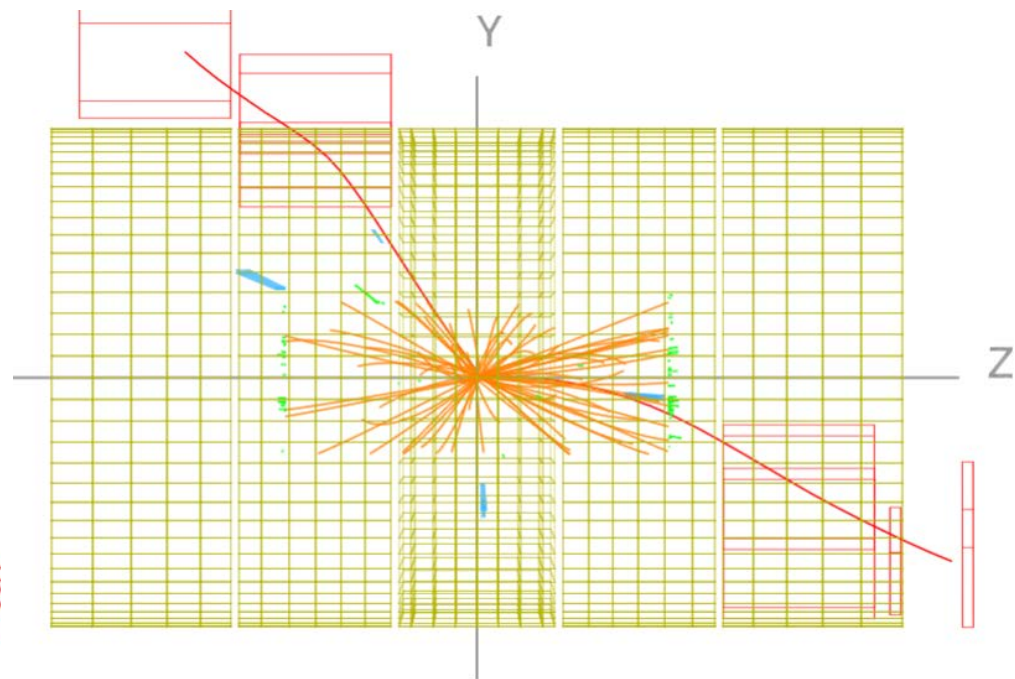

z-y view: measure  $\theta$

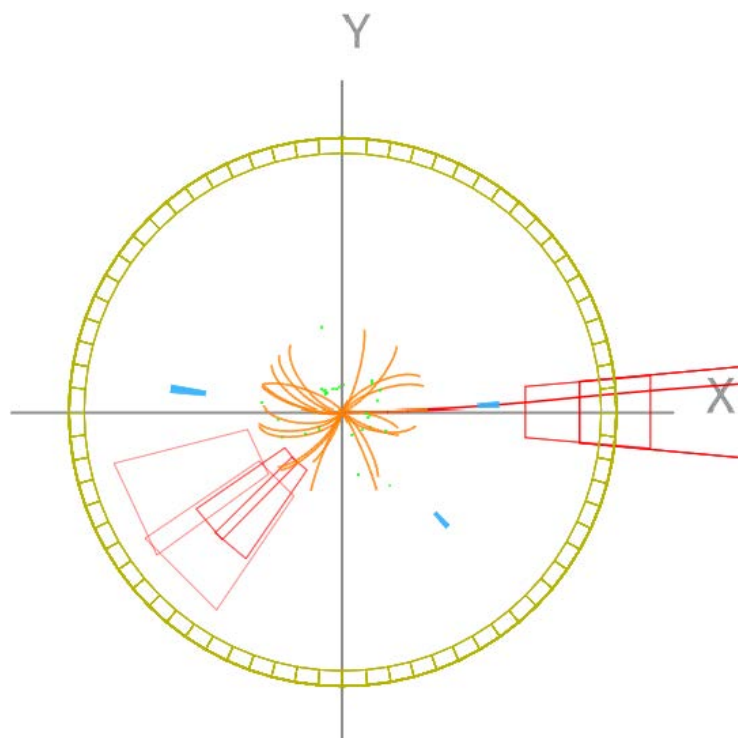

x-y view: measure  $\phi$

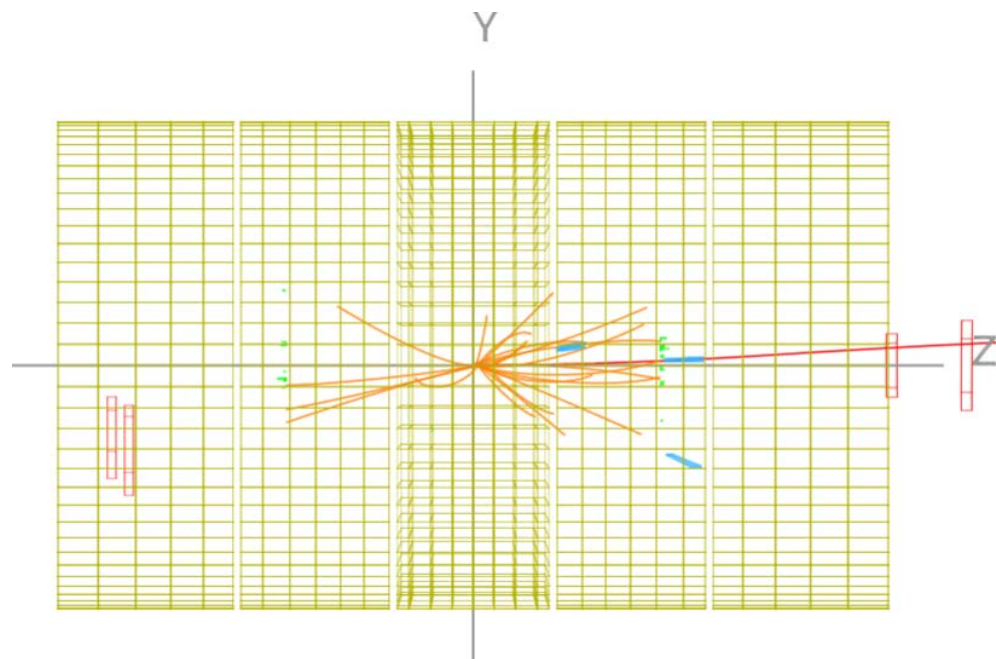

z-y view: measure  $\theta$